

# Smart Graphics: Milestones: Interactive SG Systems

Vorlesung „Smart Graphics“

## Topics today

- So far only: intelligent generation of graphics
- Today: analysis, matching and processing of graphics and input according to cognitive criteria
- → different meaning of „Smart Graphics“
- Querying
  - Bitmap images
  - Vector drawings
  - 3D models
- Sketching
  - Simple polygonal shapes
  - Organic 3D models

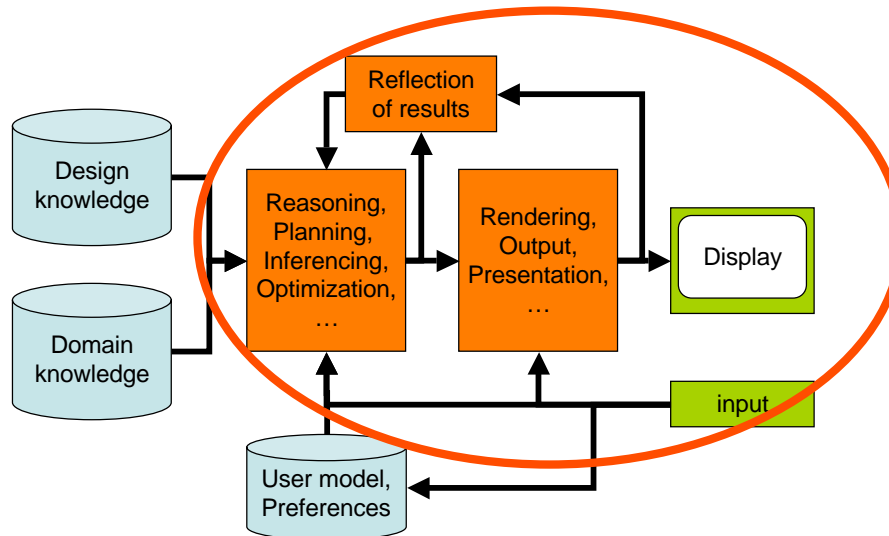

..not so sure this model still works here...

## Visual & tangible image query



Kresimir Matkovic et al.  
Smart Graphics 2002 & 2004

## Motivation

- Increasing amounts of image material exist
- Mechanisms for retrieval are insufficient
  - File name
  - Recorded meta data (Date, camera,...)
  - Manually entered meta data
  - (Image analysis, shapes, ??)
- Needed: visual input for retrieval
  - Find images with similar shapes
  - ..with similar colors
  - ..with similar color layout

## Approach

- Go through the image database and compute a descriptor for each image
- Compute the same descriptor for the example image
- Compare with all the image descriptors
  - Standard indexing approach
  
- → How is the descriptor computed?

## Computing image descriptors (1)

- Scale images to 128x128
- Reduce color depth
  - To reduce errors by slightly differing but similar colors
  - Done in CIE HSL (Hue, Saturation, Lightness) space
  - Only 8 basic hues: yellow, orange, red, magenta, violet, blue, cyan, cold green, and warm green
  - Only 5 steps for lightness and saturation



## Computing image descriptors (2)

- Place 1.000 rectangles in the image
  - Various sizes and orientations
  - Various positions
  - Distribution semi-randomly
- Compute mean colors for each rectangle → store
  - Using summed area tables
  - Multi-resolution strategy
- Compute a reduced histogram → store

## Image retrieval

- Compute same descriptor for example image
- Compare in perceptually uniform color space
- Exclude results with incompatible histogram
- Rate, rank and show results

## Before Histogram check

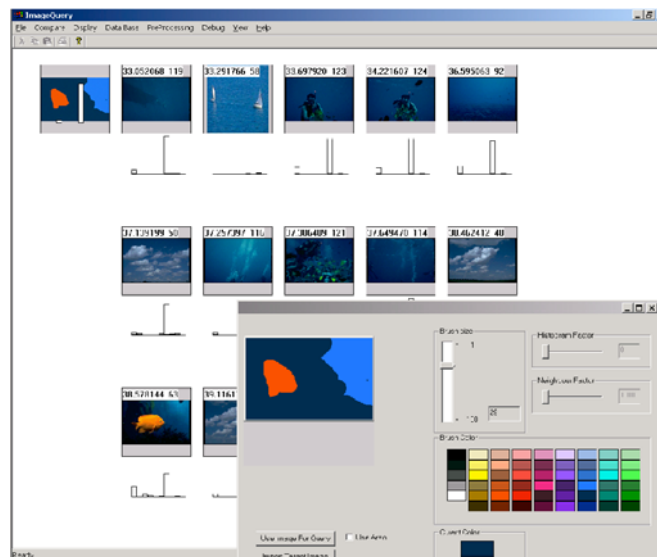

## After Histogram check

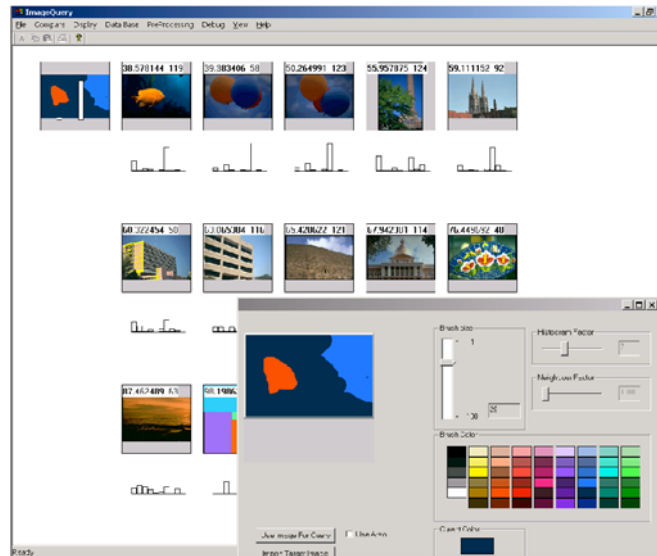

LMU München – Medieninformatik – Butz/Boring – Smart Graphics – SS2007 – Methoden: Graph Drawing – Folie 11

## Sketching the example image

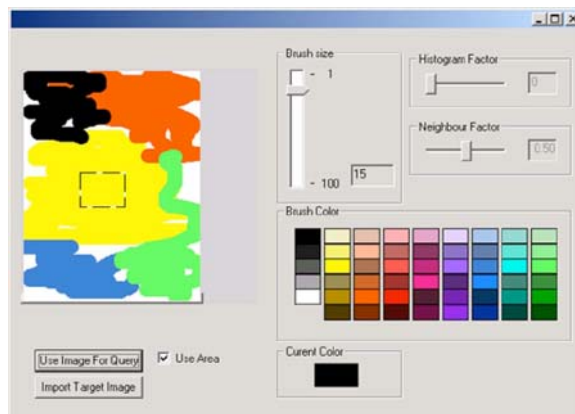

- Very reduced color palette
- Only abstract color distribution important

LMU München – Medieninformatik – Butz/Boring – Smart Graphics – SS2007 – Methoden: Graph Drawing – Folie 12

# Results (1)

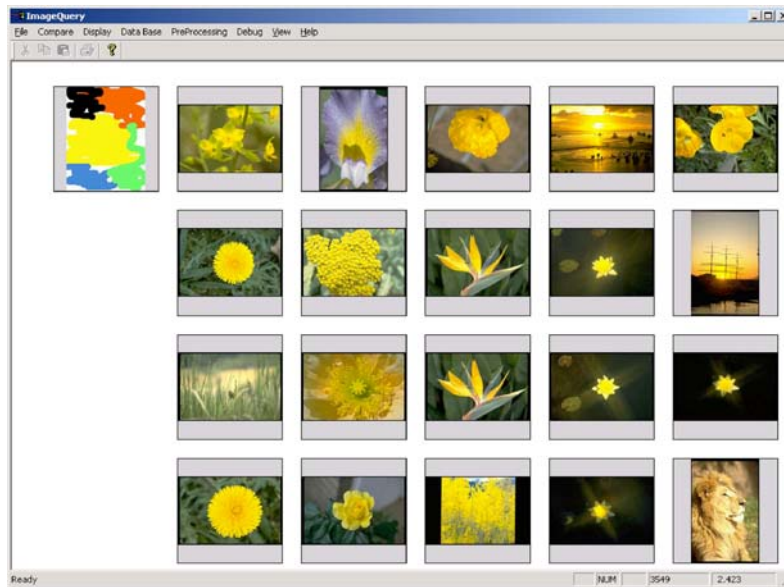

LMU München – Medieninformatik – Butz/Boring – Smart Graphics – SS2007 – Methoden: Graph Drawing – Folie 13

# Results (2)

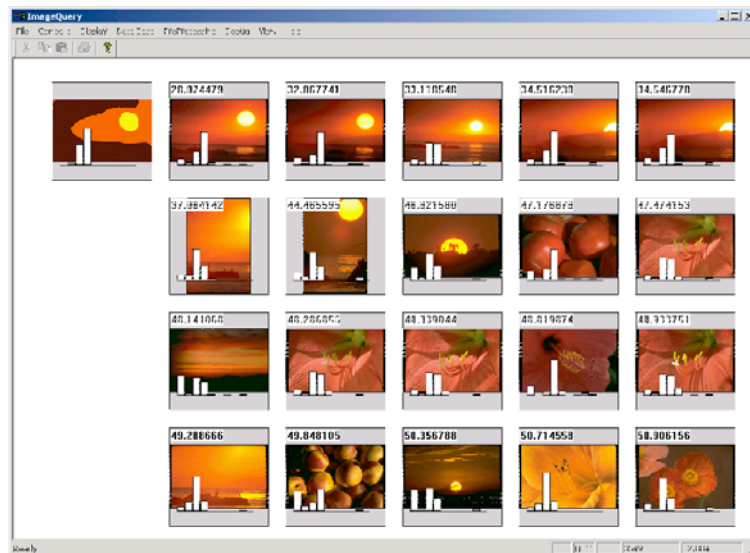

LMU München – Medieninformatik – Butz/Boring – Smart Graphics – SS2007 – Methoden: Graph Drawing – Folie 14

## Results (3)

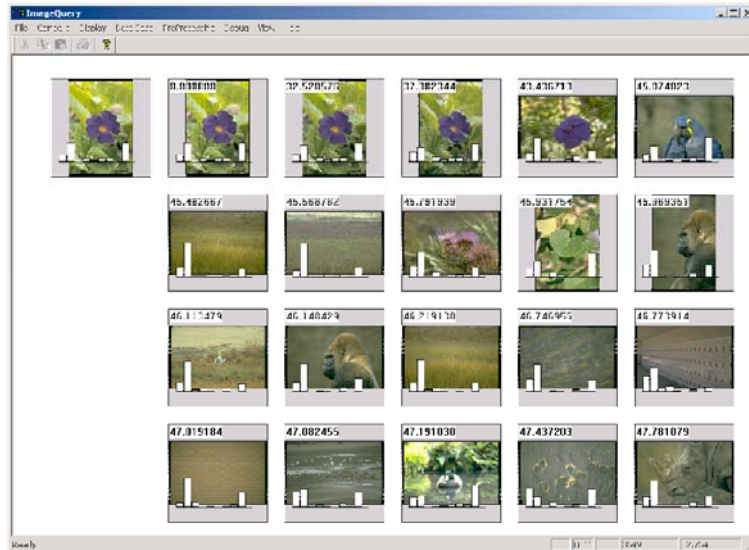

LMU München – Medieninformatik – Butz/Boring – Smart Graphics – SS2007 – Methoden: Graph Drawing – Folie 15

## Improvement

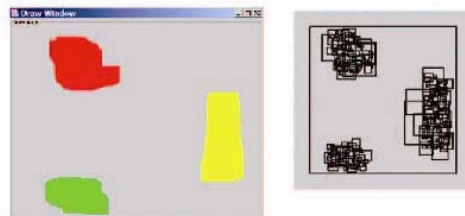
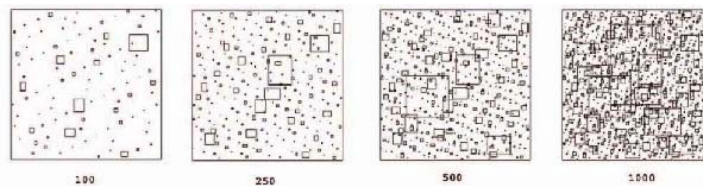

- Use only the rectangles in which the user has actually sketched

LMU München – Medieninformatik – Butz/Boring – Smart Graphics – SS2007 – Methoden: Graph Drawing – Folie 16



## Tangible Image Query <http://www.vrvis.at/scivis/TIQ/>

- Instead of sketching: arrange colored blocks and things
- Camera under a semitransparent surface (real time)
- Can record colors without too much external influences
- Alternative: use a scanner above the table (not real time)
- Higher quality but less interactivity

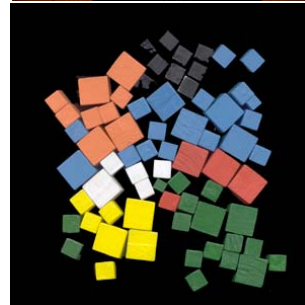
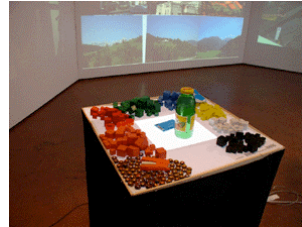

## Results

- Comparison with sketching input
- Tangible input faster
- Better acceptance

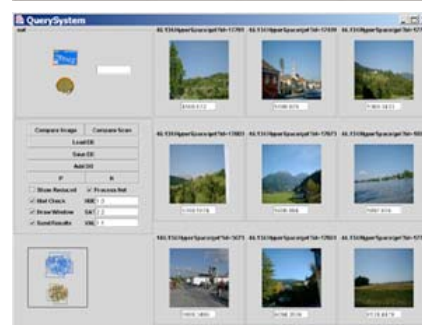
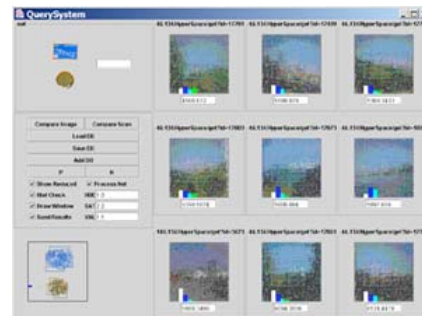
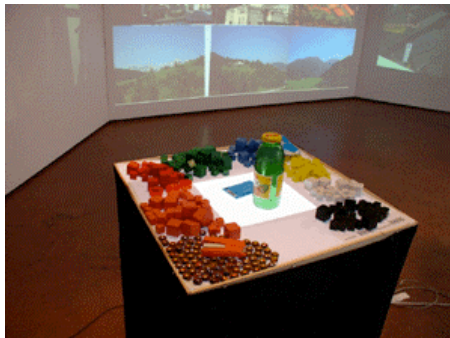

## Retrieving vector graphics



Manuel J. Fonseca et al.  
Smart Graphics 2004

## Motivation

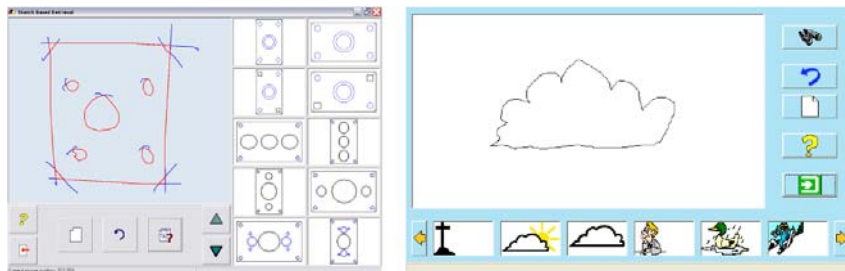

- Browse large collections of vector graphics
  - Technical drawings
  - Clip art
- Find structurally similar drawings

## Geometry and topology analysis

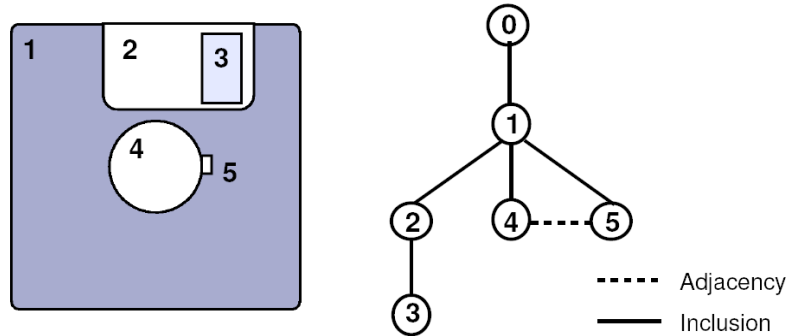

- Decompose drawing into its base polygons
  - Discard small details
- Analyze them for adjacency and inclusion
- Store a topology graph of the drawing

## Computing Descriptors from graphs

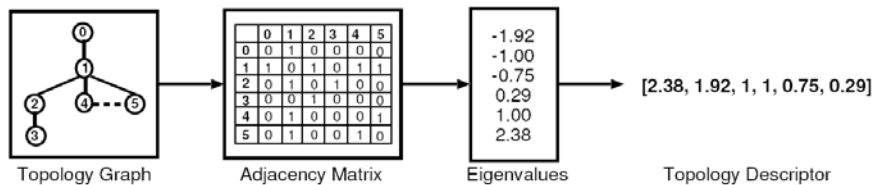

- Problem: graph matching is NP-complete
- Solution: compute a vector from the Eigenvalues of the adjacency matrix, describing the graph
  - High-dimensional for complex drawings
  - Low-dimensional for simple
  - Similar for structurally similar graphs
  - Stable with small changes in graph topology
- Do this at different levels of detail and for subgraphs

## Sketched input

- Identify shapes from hand-sketched input
- Transform sketch into vector graphics
- Apply same analysis as for the DB

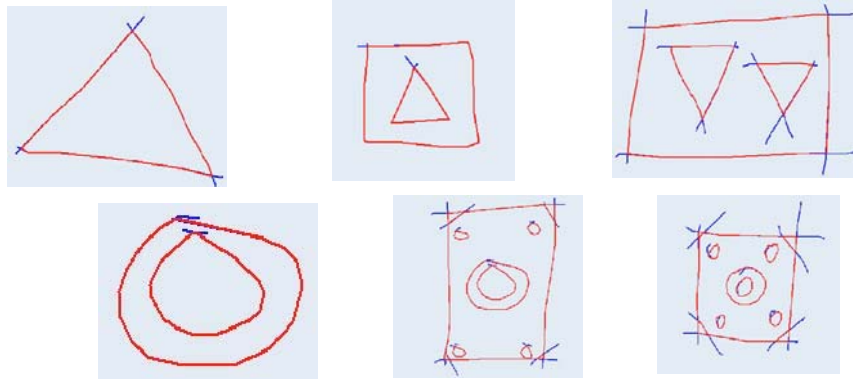

LMU München – Medieninformatik – Butz/Boring – Smart Graphics – SS2007 – Methoden: Graph Drawing – Folie 23

## Analyzing clip art

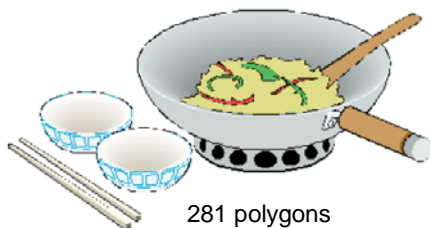

- WMF format uses 2 polygons for area and outline → discard one
- Clip art uses polygons with color gradients
  - Problem: shapes are found by color
  - → Simplify to uniform colors

LMU München – Medieninformatik – Butz/Boring – Smart Graphics – SS2007 – Methoden: Graph Drawing – Folie 24

## Matching

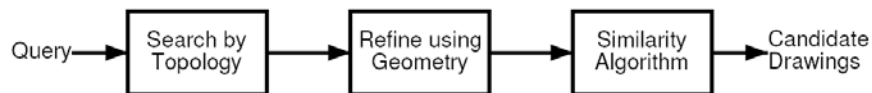

- Compute the same descriptors from the query sketch
  - 1) find topologically similar drawings
  - 2) compare geometries used in the drawings
  - 3) compute a similarity measure
- Return a ranked list of matches
- Tested for 100.000 drawings

## Retrieving 3D models based on their shape



Thomas A. Funkhouser

<http://shape.cs.princeton.edu/>

## Motivation

- shape-based retrieval and analysis of 3D models
  - To query model databases
  - To classify 3D models
- develop effective shape representations
- develop effective query interfaces

## Shape Distributions

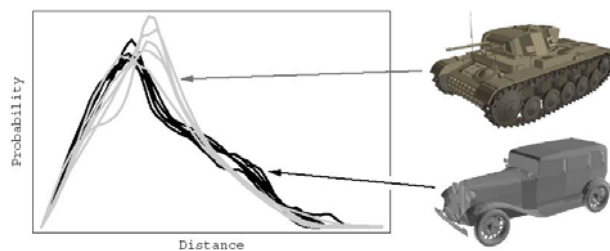

- E.g., probability distribution of Euclidean distances between pairs of randomly selected points on its surface
- samples can be computed quickly and easily
- resulting distributions are invariant to similarity transformations, noise, tessellation, cracks, etc.
- normalization step for scale invariance

## Reflective Symmetry Descriptors

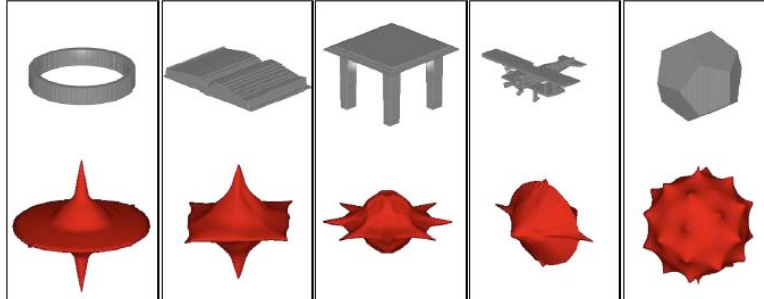

- Put planes through the object's center of mass
- Determine reflective symmetry w/r to these planes
- Scale a unit sphere with the degree of symmetry along the normal vector of the plane
- → descriptor is invariant with scale, easily comparable
- → describes global symmetry properties of a 3D shape

## Spherical Harmonics

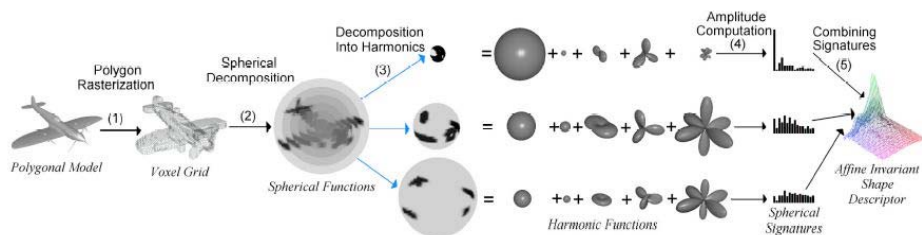

- Compute voxel grid from model
- Sample it on spheres around the center of mass
- Decompose results into harmonic base frequencies (like Fourier transform)
  - Invariant under rotation!
- Combine signatures to a complete shape descriptor
  - Invariant under affine transformations

## Skeletal Graphs



- Transform object into voxels
- Skeletonize it, i.e. compute center lines
- Derive a structure graph from this skeleton
  - Invariant with scale
  - Similar for similar shapes
- → see vector graphics retrieval 10 min. ago ;-)

## Query interfaces

### Text & 3D Sketch

**Search**

Keywords:



**Undo** **Clear**

You're using **Teddy**, written by Takeo Igarashi.  
Click [here](#) for a short usage tutorial.

### File Compare

**Search**

Specify local file to compare:  
 **Browse...**

Here you can specify the path to your own 3D model file (for example `c:\my\models\dolphin.vrx`) and match it against our database.

### Text & 2D Sketch

**Search**

Keywords:

**View 1**



**Undo** **Clear**

**View 2**

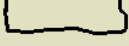

**Undo** **Clear**

**View 3**

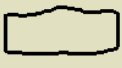

**Undo** **Clear**



## Results (Movie)

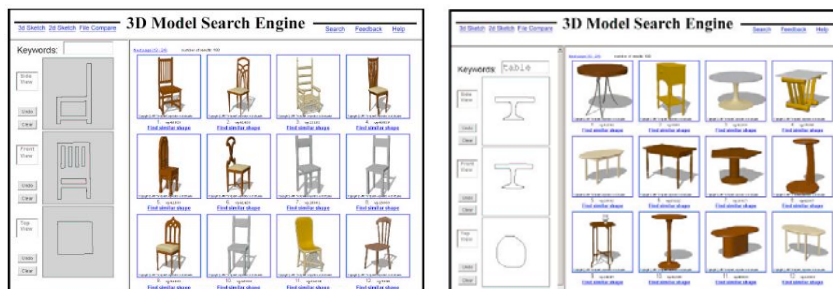
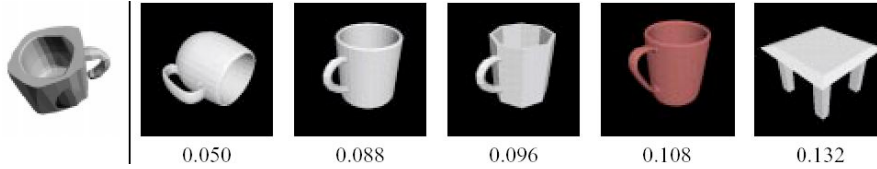

## 3D sketching 1



Some of Takeo Igarashi's work

## Teddy [Igarashi, Siggraph 99]

- Idea: sketch shapes of freeform objects on a 2D surface
- Inflate the shape in both directions with the amount dep. on its width
- Allow extrusions and boolean operations
- Allow deformations of objects

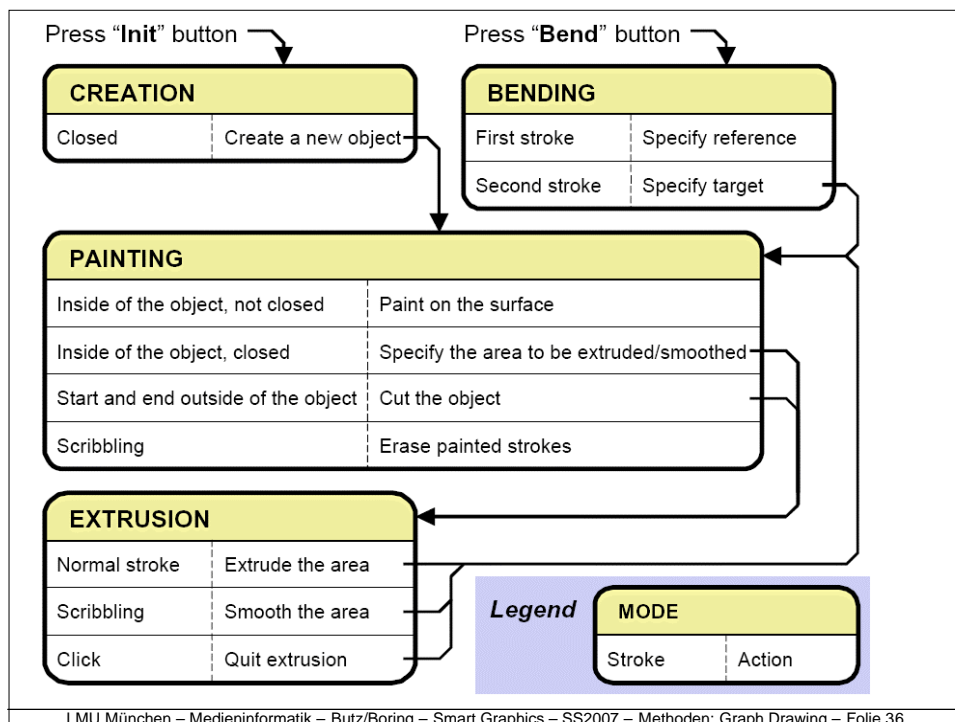
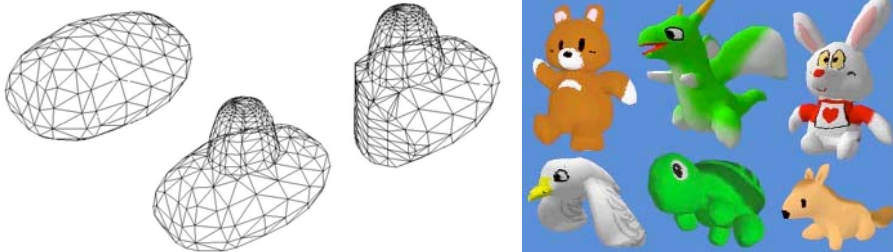

## Basic shapes and painting



a) initial state    b) input stroke    c) result of creation    d) rotated view

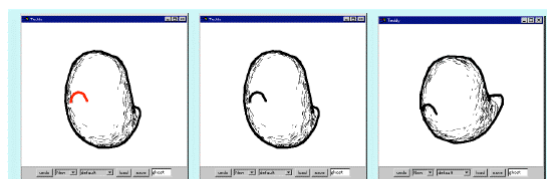

e) painting stroke    f) result of painting    g) rotated view

## Finding the spine

- Constrained Delaunay Triangulation
- 3 classes of triangles
  - Terminal (2 outer edges)
  - Sleeve (1 outer edge)
  - Junction (no o. edge)
- Expand T triangles →
- Create „fan triangles“ →
- Spine = line through midpoints of interior edges of S triangles

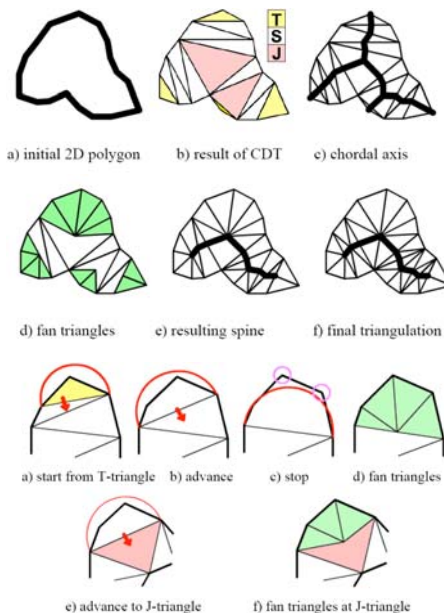

## Inflating the spine

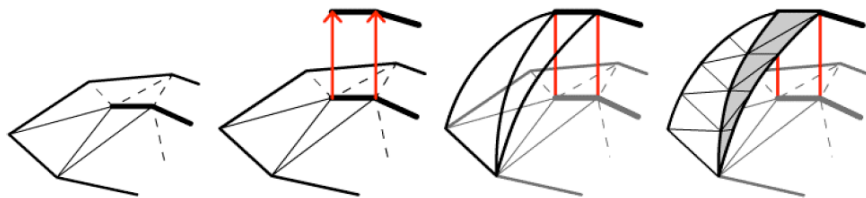

a) before    b) elevate spines    c) elevate edges    d) sew elevated edges

- Split polygons at the spine
- Elevate the spine, depending on shape width
- Elevate the edges such that intersections form ovals
- Sew the elevated edges together again.

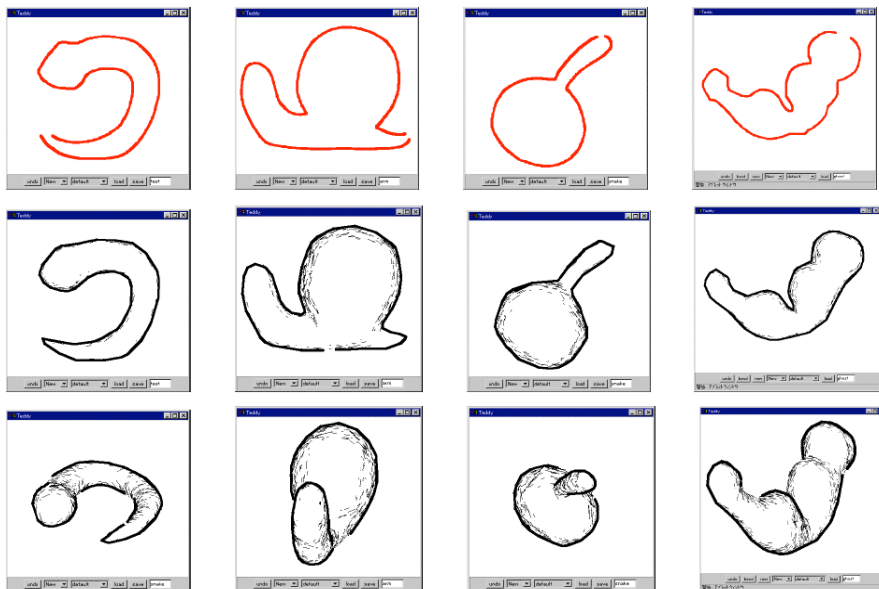

a) snake    b) snail    c) cherry    d) muscular arm

## Painting on the surface

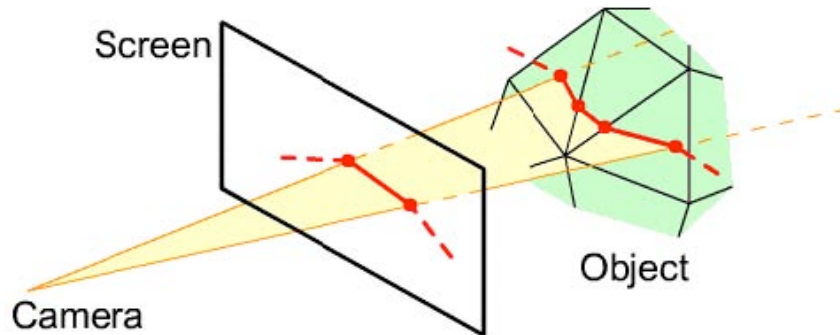

- Project the pen stroke onto the object surface

h) before extrusion	i) closed stroke	j) rotated view	k) extruding stroke	l) result of extrusion	m) result of click
n) before cutting	o) cutting stroke	p) result of cutting	q) result of click		
r) extrusion after cutting	s) result of extrusion	t) rotated view			

**Extrusion & cutting**

# Extrusion

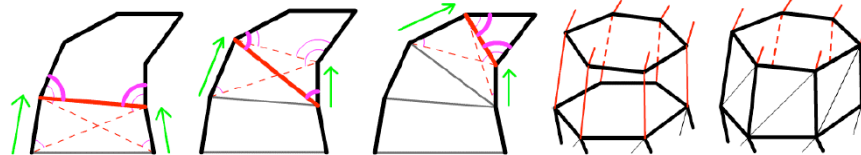
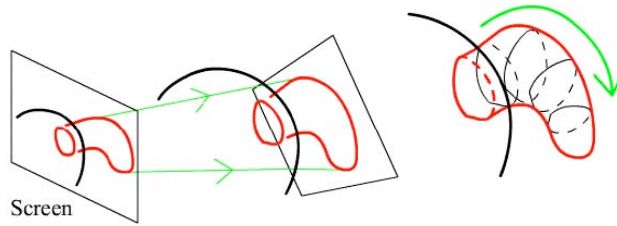

a) pointer advancing

b) sewing adjacent rings

- Project extrusion stroke to a plane in space,
  - perpendicular to the base ring
  - projection onto screen matches original stroke
- Sweep base ring along extrusion by alternatingly moving 2 pointers
- Connect the new rings, cut out the original base ring, sew together



a) long

b) thin

c) fat

d) sharp

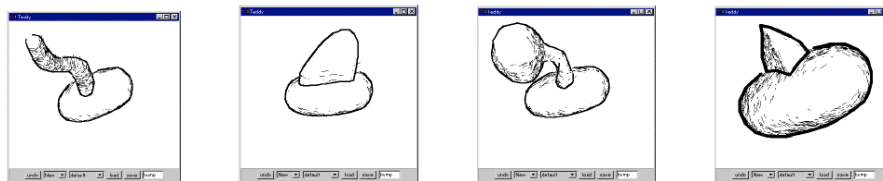

a) digging stroke b) result

c) rotated

d) closed stroke e) after click

# Cutting

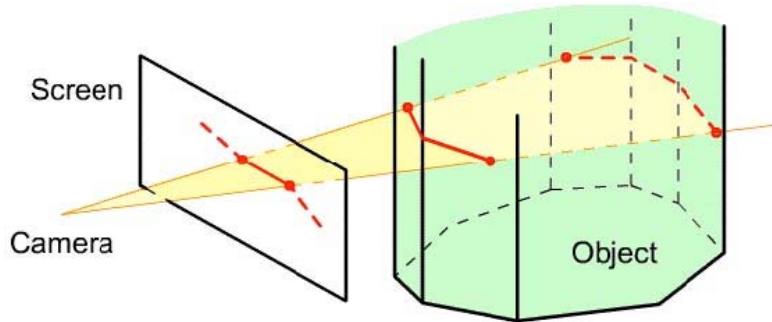

- Similar to painting
- Projection onto object's front and back sides
- Connect front and back points with a planar polygon

# Examples

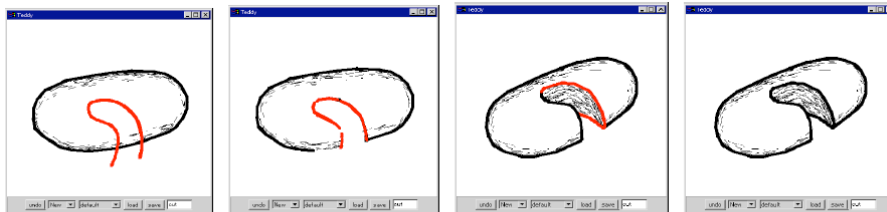

a) biting stroke    b) result    c) rotated view    d) after click

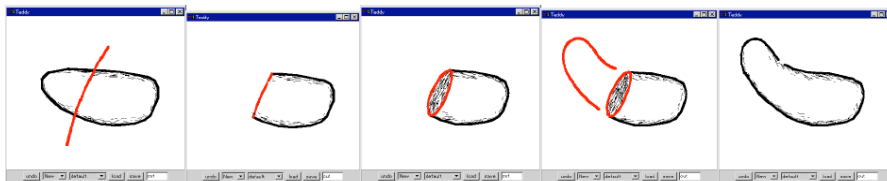

a) cutting stroke    b) result    c) rotated    d) extruding stroke    e) result

## Erasing

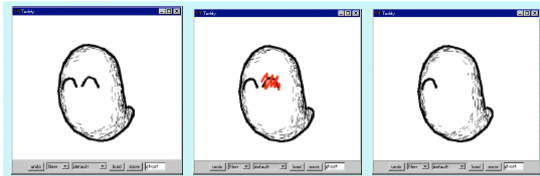

u) before erasing    v) scribbling    w) result of erasing

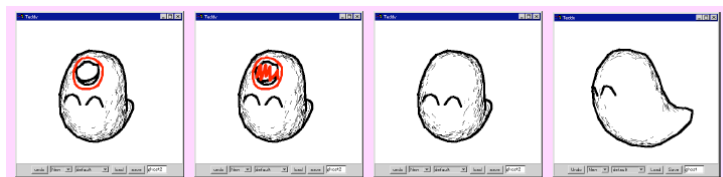

x) closed stroke    y) scribbling    z) result of smoothing    z') rotated view

## Examples



a) cleaning a cavity

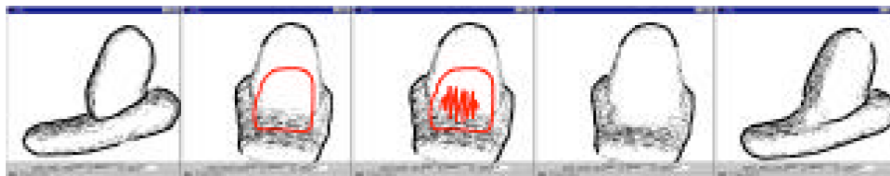

b) smoothing a sharp edge



## Transformation

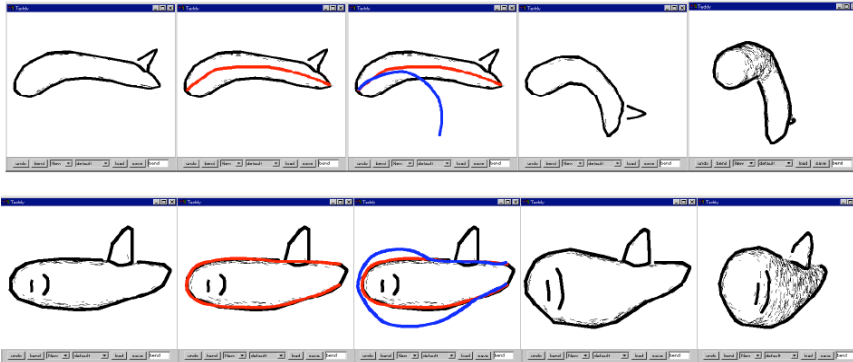

a) original b) reference stroke c) target stroke d) result e) rotated

## 3D sketching 2

Ferran Naya et al.  
Smart Graphics 2003

## 3D Reconstruction based modeling

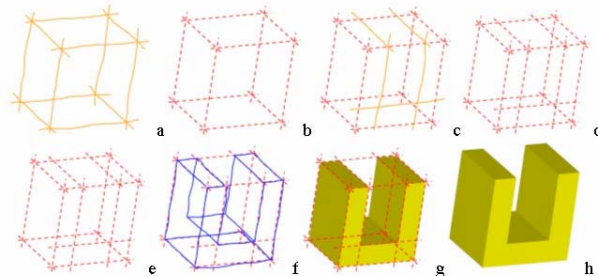

- Draw line strokes on the screen with pen (light pressure)
- Use them as leader lines as a reference frame
  - constant camera position
- Draw strong lines along leader lines to form a 3D model
- When a valid 3D model is recognized → shade

LMU München – Medieninformatik – Butz/Boring – Smart Graphics – SS2007 – Methoden: Graph Drawing – Folie 51

## Line stroke beautification

- Automatic line slope adjustment
  - checking whether the new line is parallel to any of the principal axes of the sketch within a slope tolerance.
- Vertex point snap
  - look for vertices close to the line endpoints, within a given proximity tolerance.
  - If several such vertices, select the one closest to that line endpoint.
- Vertex on line snap and automatic line breaking
  - for endpoints of the new line which do not lie close to a model vertex, analyze whether the points are close to an existing edge, within a given tolerance.

LMU München – Medieninformatik – Butz/Boring – Smart Graphics – SS2007 – Methoden: Graph Drawing – Folie 52

## Inflation

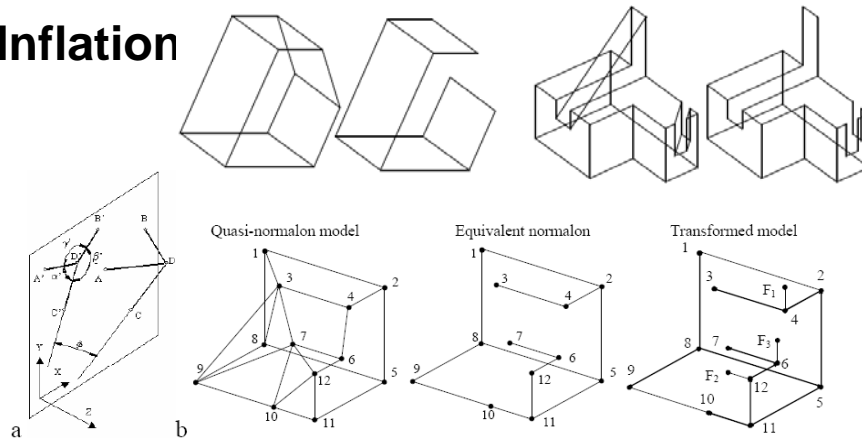

- Assume only right angles in objects (normalon)
- Analytically determine the orientation for each corner based on its edges to adjacent corners
- Find a plausible 3D reconstruction

## Refining geometry by additional strokes

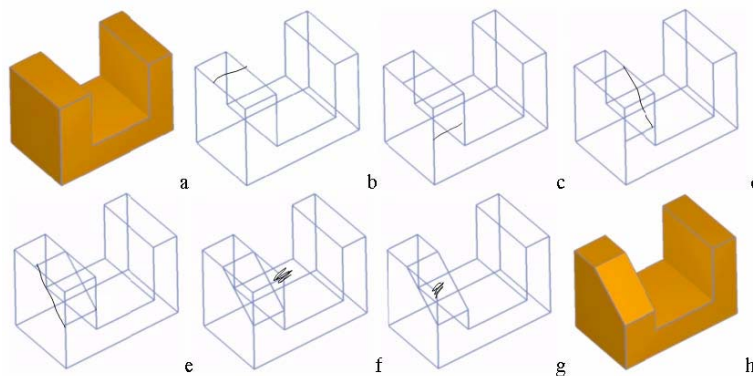

- Draw additional lines on the geometry
- Scratch gesture over edge
  - Construct smallest quadrilateral containing the gesture
  - Remove all intersecting lines

## 3D sketching 3



The classic: SKETCH

[\[Bob Zeleznik, Siggraph 96\]](#)

## Sketch: drawing a cube

- Three line segment strokes,
  - axis-aligned with coordinate axes of the world
  - all strokes meet (more or less) at a single point
- The cuboid constructed from this gesture has its dimensions determined by the strokes
- Similar ways for other primitives

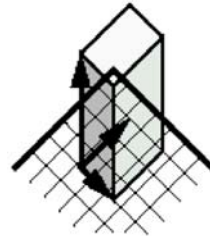

## Sketch: some results

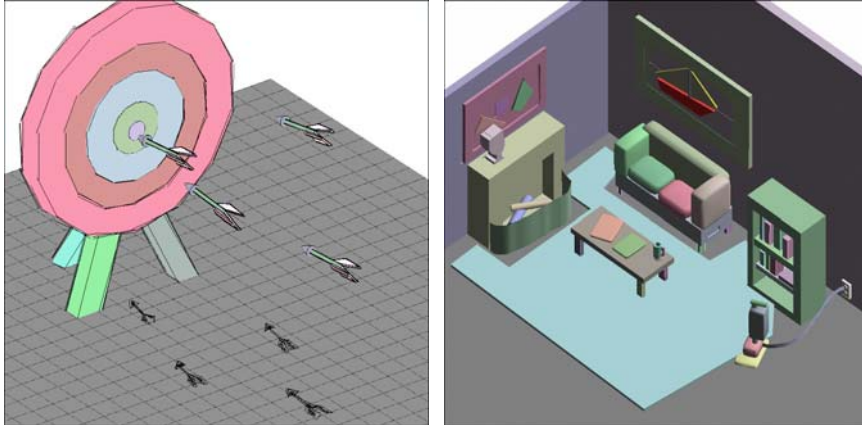

LMU München – Medieninformatik – Butz/Boring – Smart Graphics – SS2007 – Methoden: Graph Drawing – Folie 57

## More Sketching? [Google Sketchup](#)

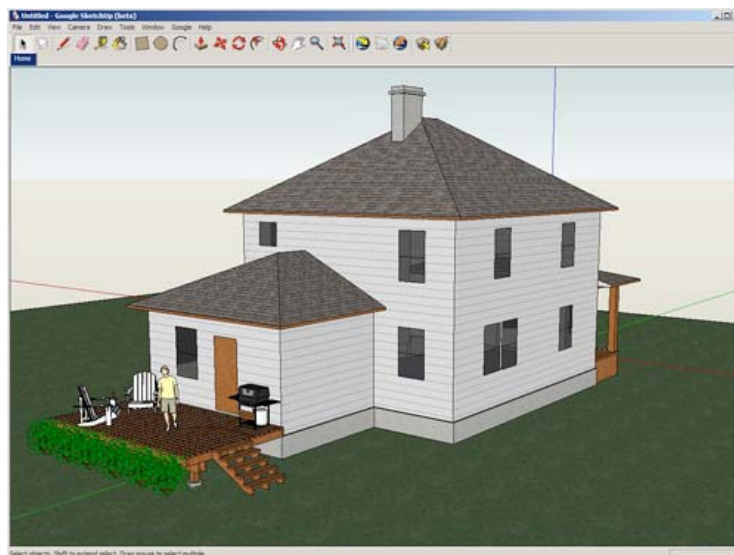

LMU München – Medieninformatik – Butz/Boring – Smart Graphics – SS2007 – Methoden: Graph Drawing – Folie 58