

Mensch-Maschine-Interaktion



Kapitel 4 - Motorik

- Fitts' Law
- Steering Law
- Interaktion mit beiden Händen

Genauigkeit vs. Geschwindigkeit

A photograph of a hand holding a pen over a wooden surface. The text 'SPEED ACCURACY' is written in white, bold, uppercase letters. Below it, the word 'TRADEOFF' is also written in white, bold, uppercase letters. A yellow sticky note is placed under the 'T' in 'TRADEOFF', and a pink sticky note is placed under the 'F'.

SPEED ACCURACY
TRADEOFF

Fitts' Experiment

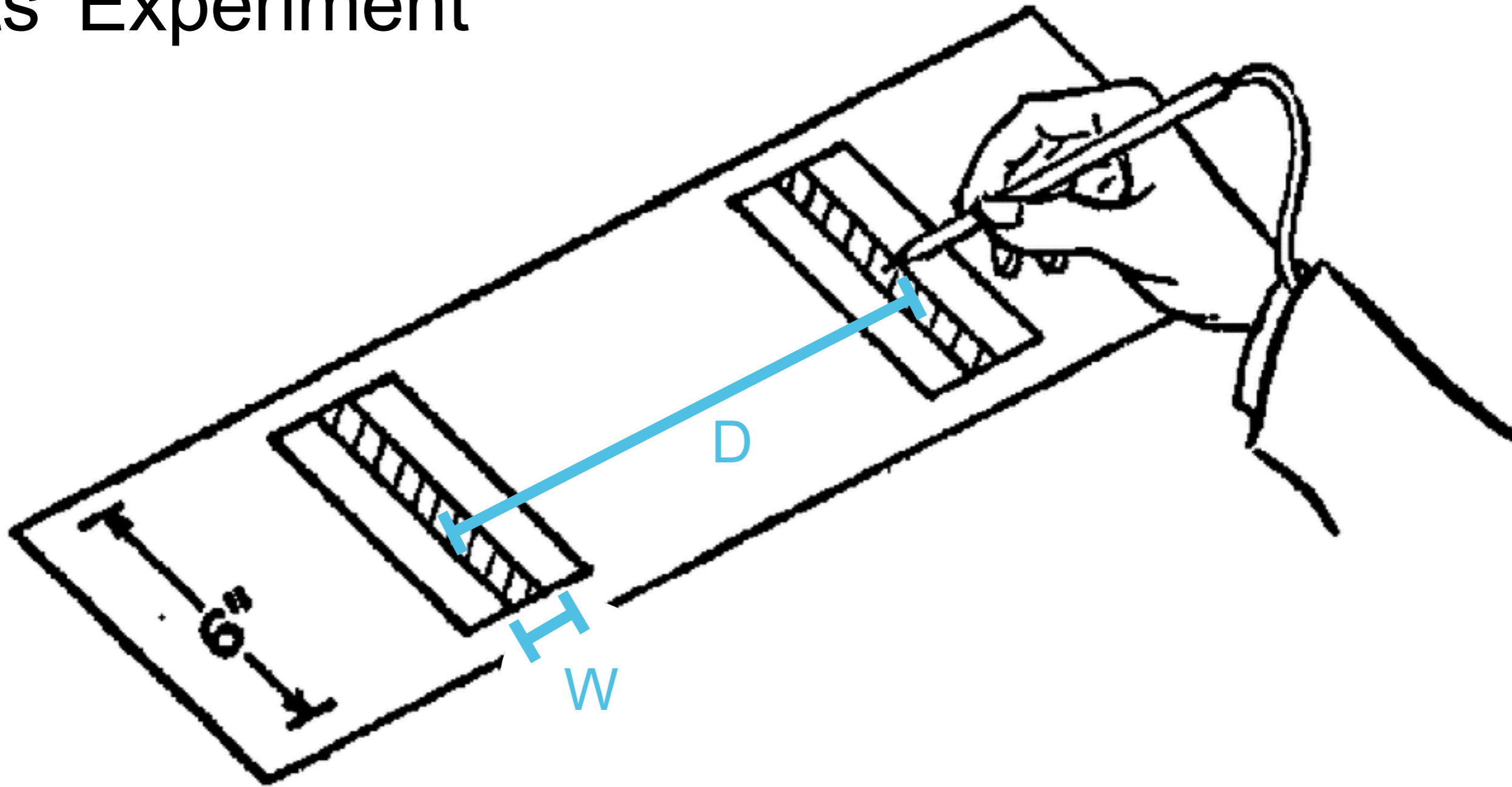

$$MT = a + b * ID = a + b * \log_2\left(\frac{D}{W} + 1\right)$$

Ziele vergrößern, aber richtig!

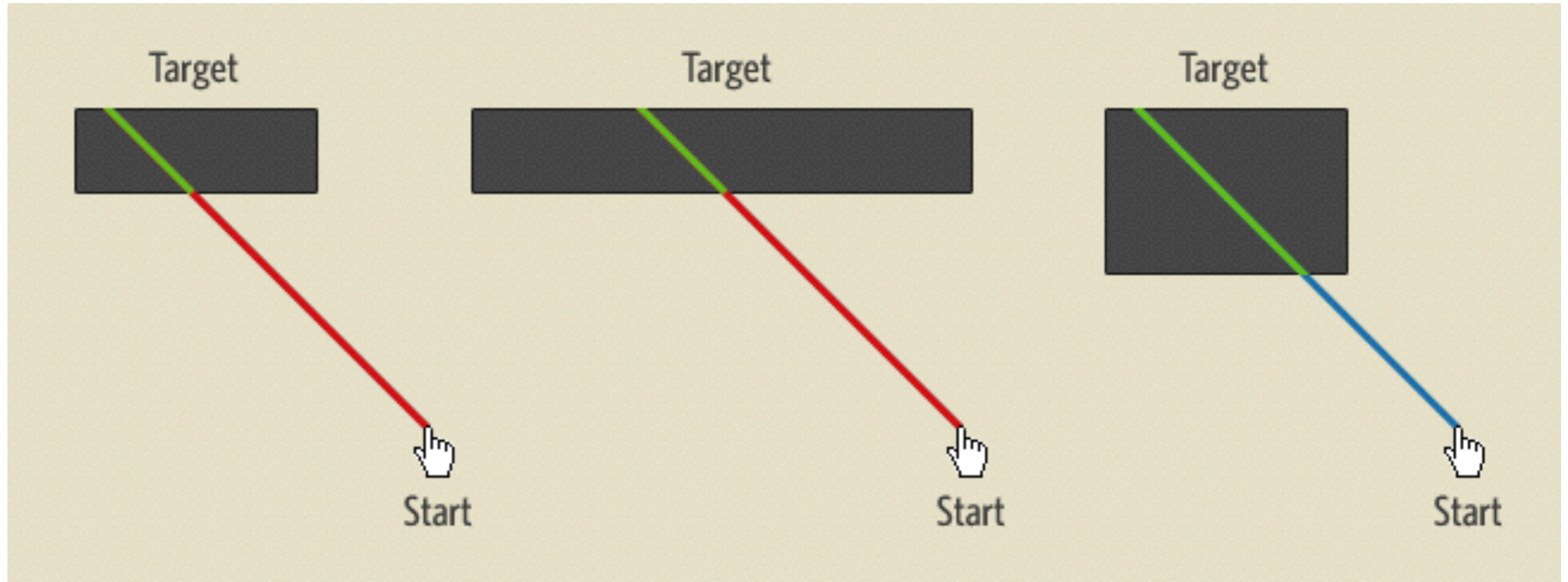

<http://www.particletree.com/features/visualizing-fittss-law/>

Nicht alle Pixel sind gleich (vor Fitts' Gesetz)

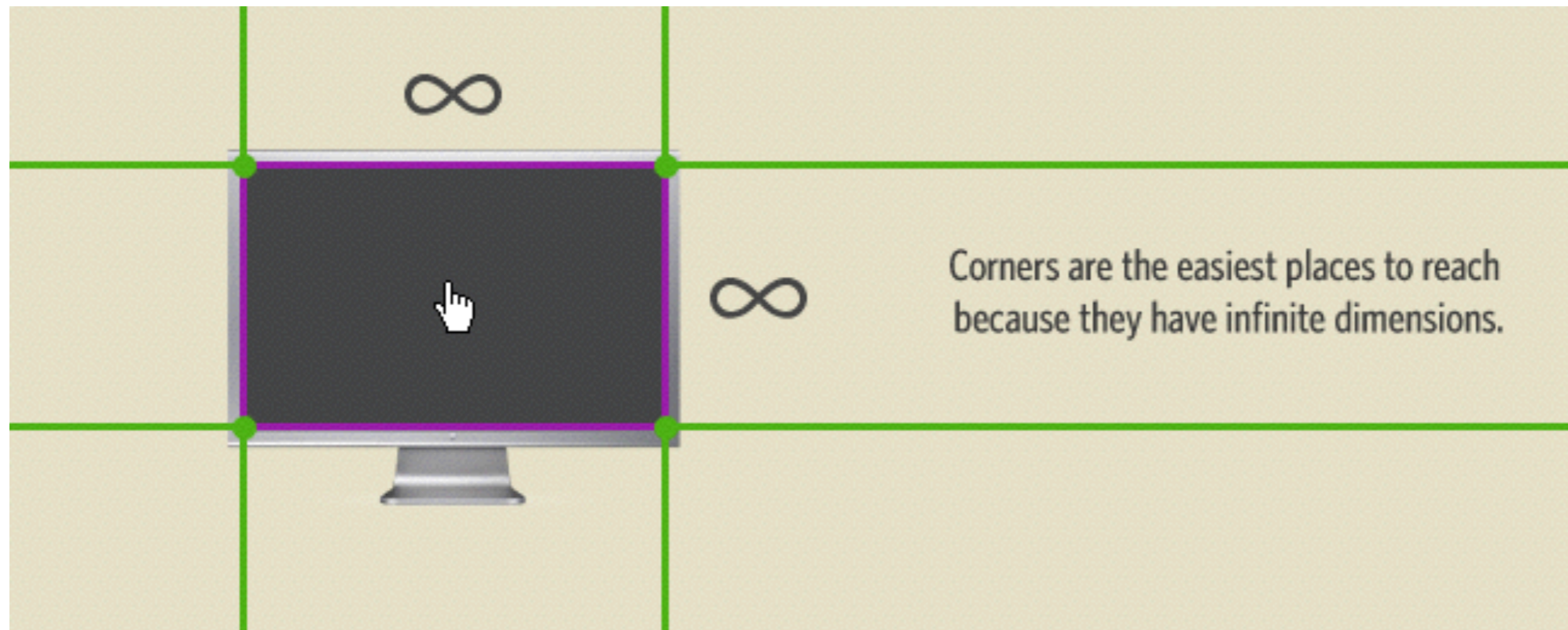
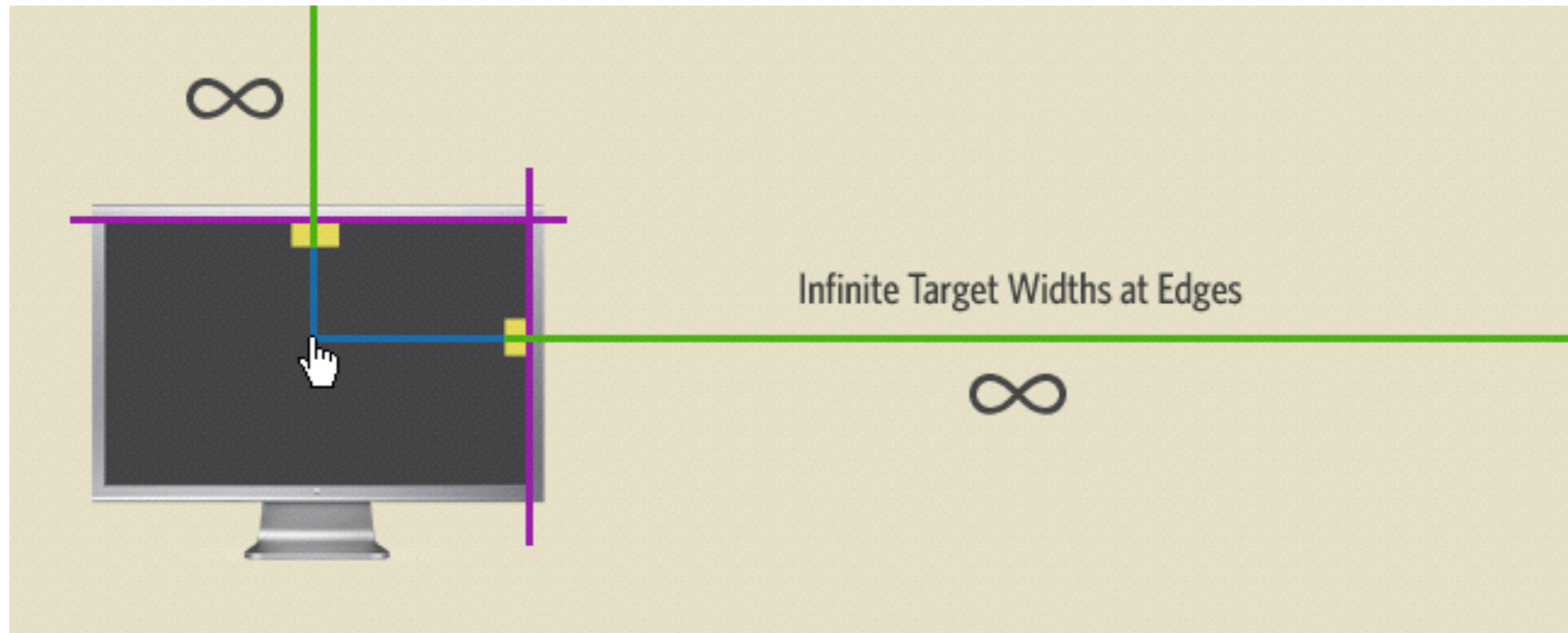

<http://www.particletree.com/features/visualizing-fittss-law/>

Diskussion: Pie Menüs

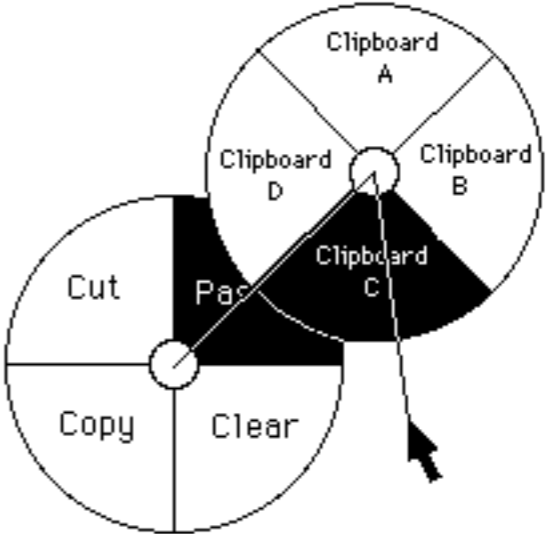
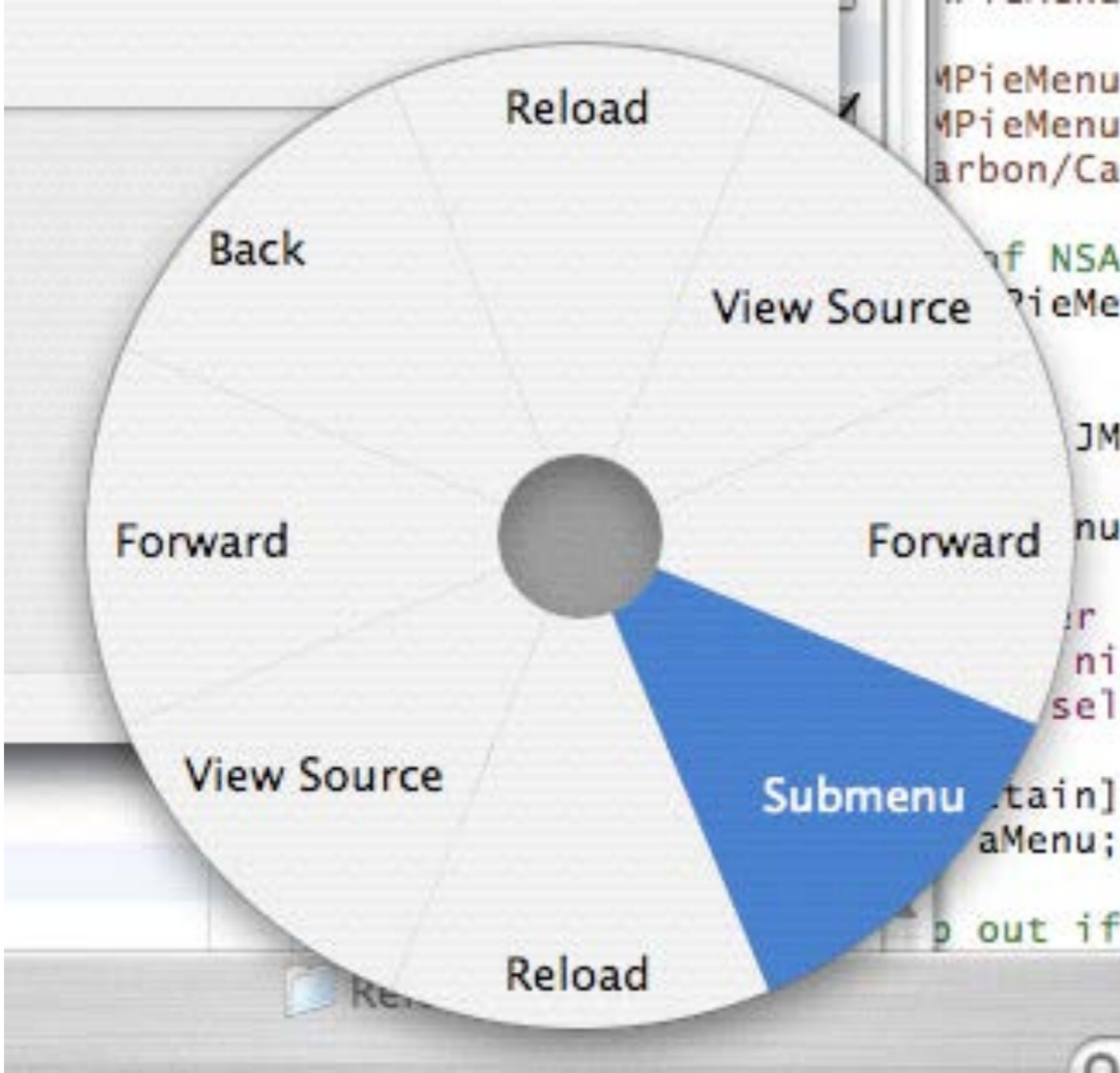

Kapitel 4 - Motorik

- Fitts' Law
- Steering Law
- Interaktion mit beiden Händen

Steuergesetz???

<http://www.all-wallpapers.net/wp-content/uploads/2012/12/Winding-Road-Nature.jpeg>



Zeit zum Befahren einer engen Straße

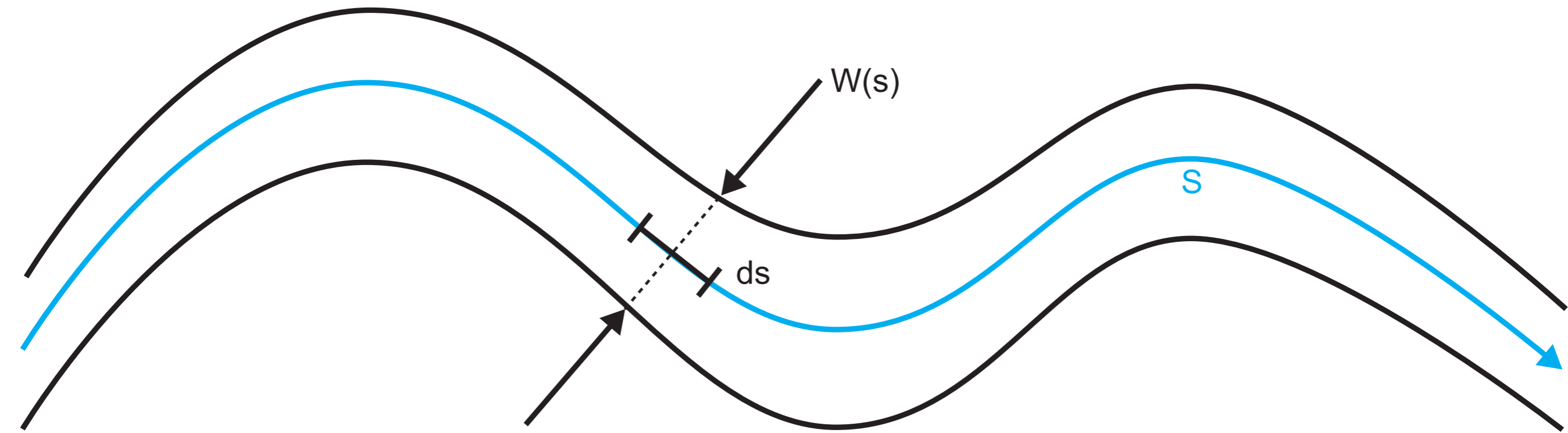

$$T = a + b * \int_S \frac{1}{W(s)} ds$$

Enge Straßen am Bildschirm

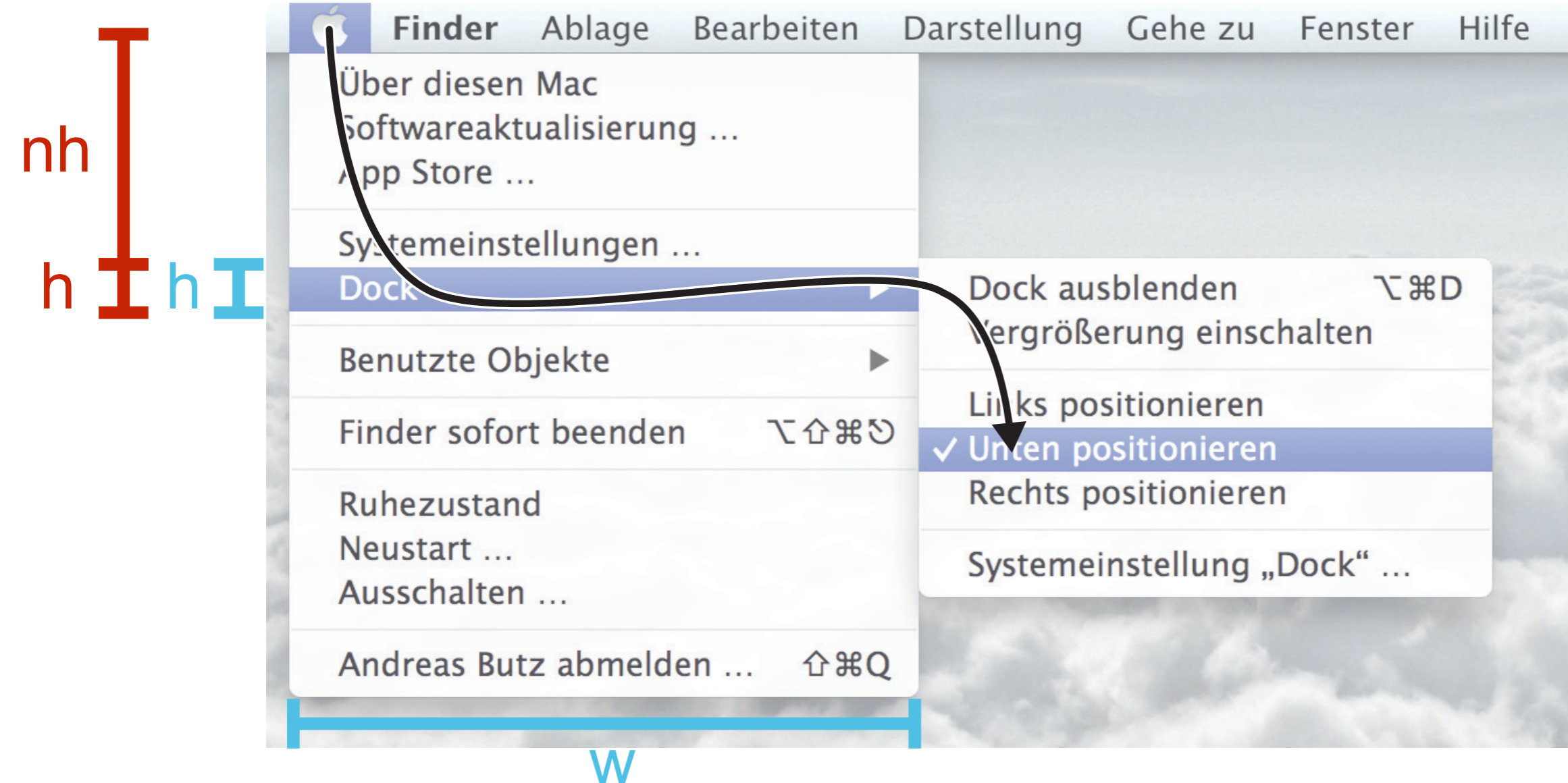

$$T = a_1 + b_1 * \log_2\left(\frac{nh}{h} + 1\right) + a_2 + b_2 * \frac{w}{h} + \dots$$

vertikal: Fitts' law

horizontal: steering law

Kurz Nachdenken: Computerspiele

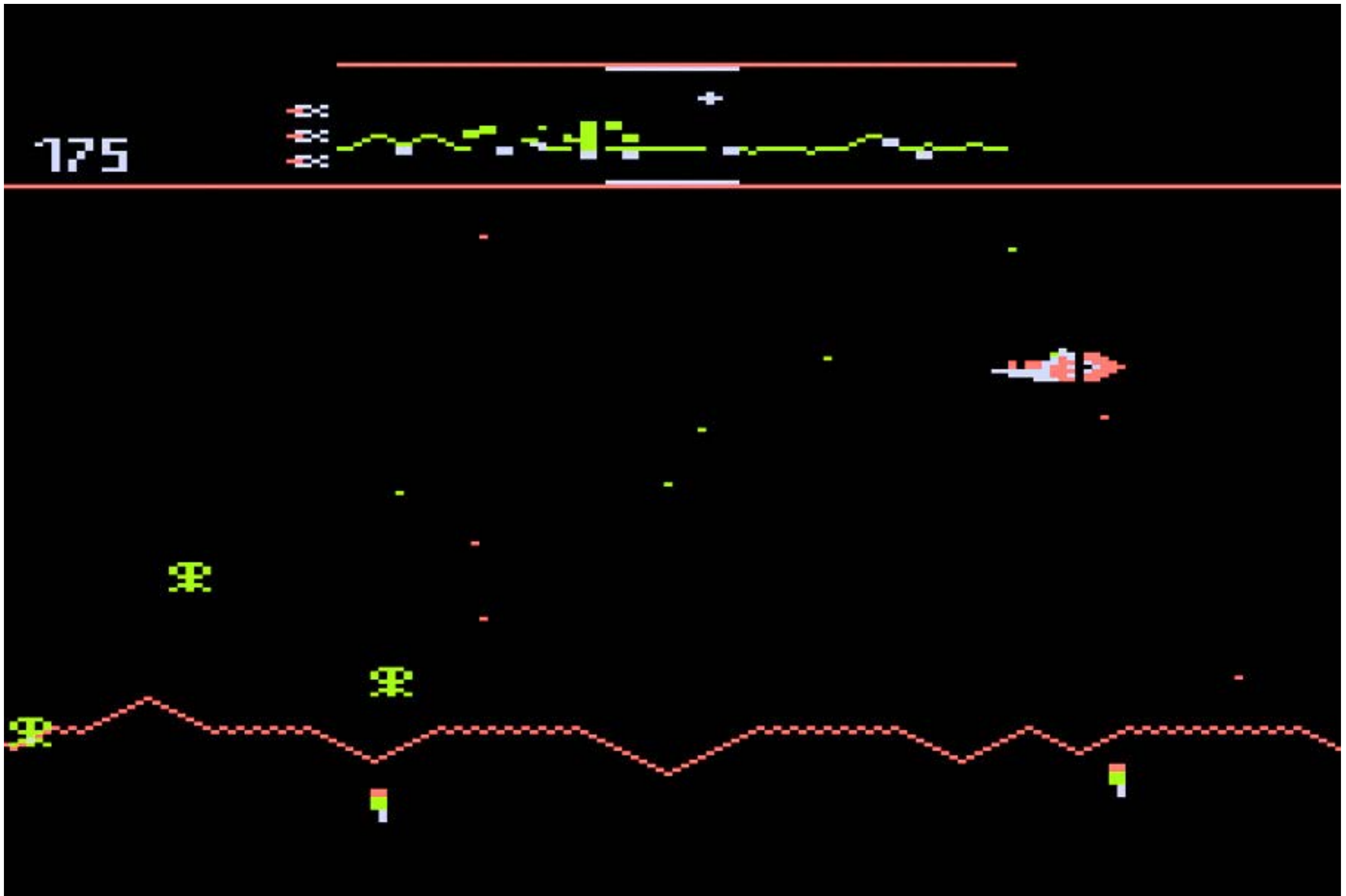

Kapitel 4 - Motorik

- Fitts' Law
- Steering Law
- Interaktion mit beiden Händen



Yves Guiard's Experiment

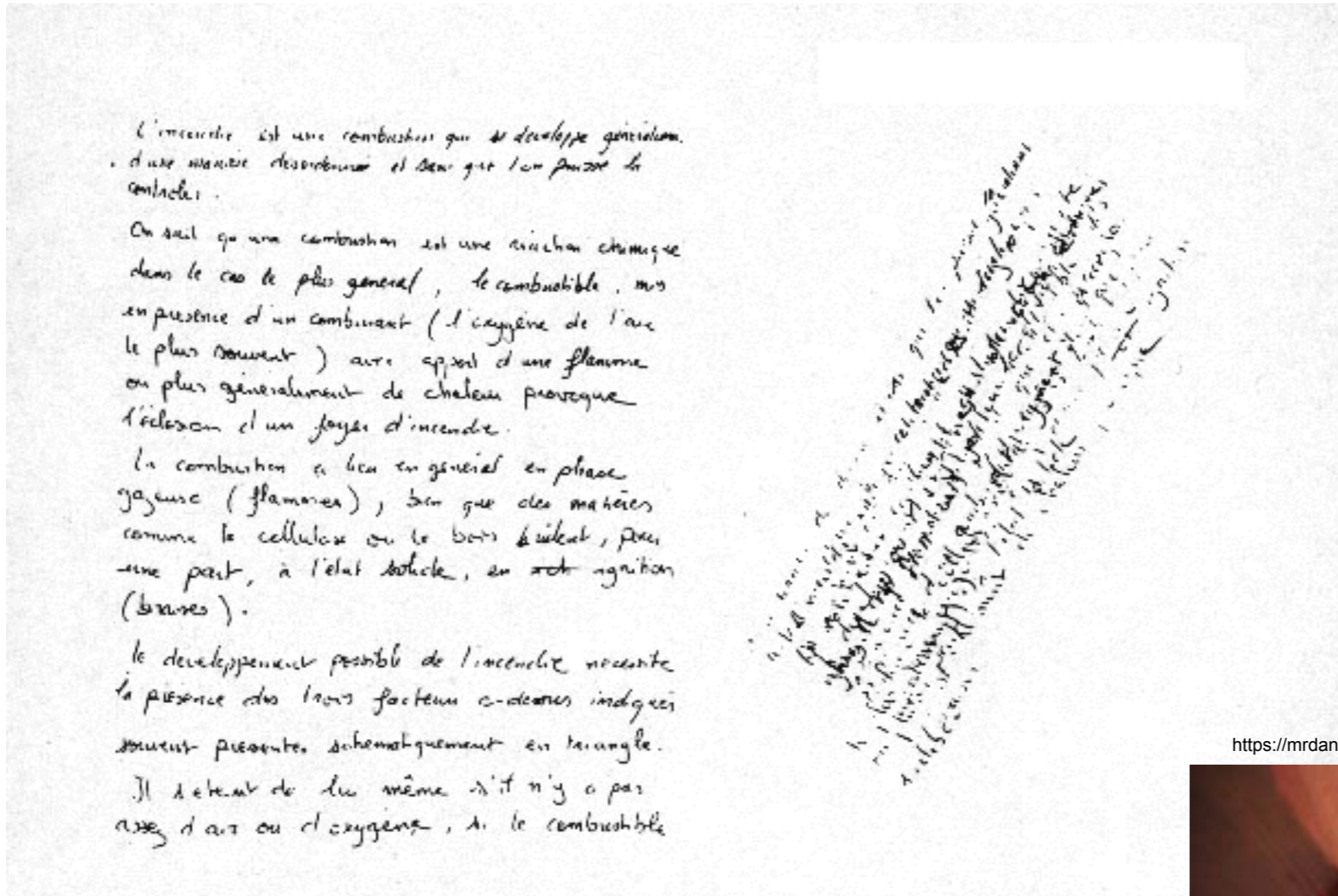

http://cogprints.org/625/1/jmb_87.html

https://mrdanbaird.files.wordpress.com/2014/01/wp-id-3293117576_05f43d8305_b.jpg?w=1024



Beispiel: Golfspieler

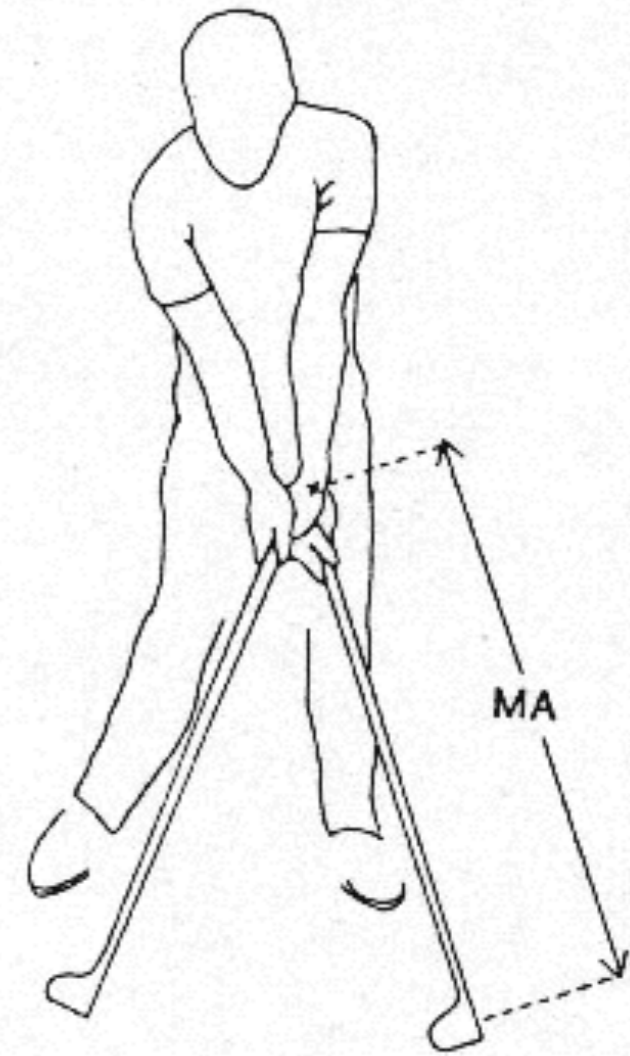
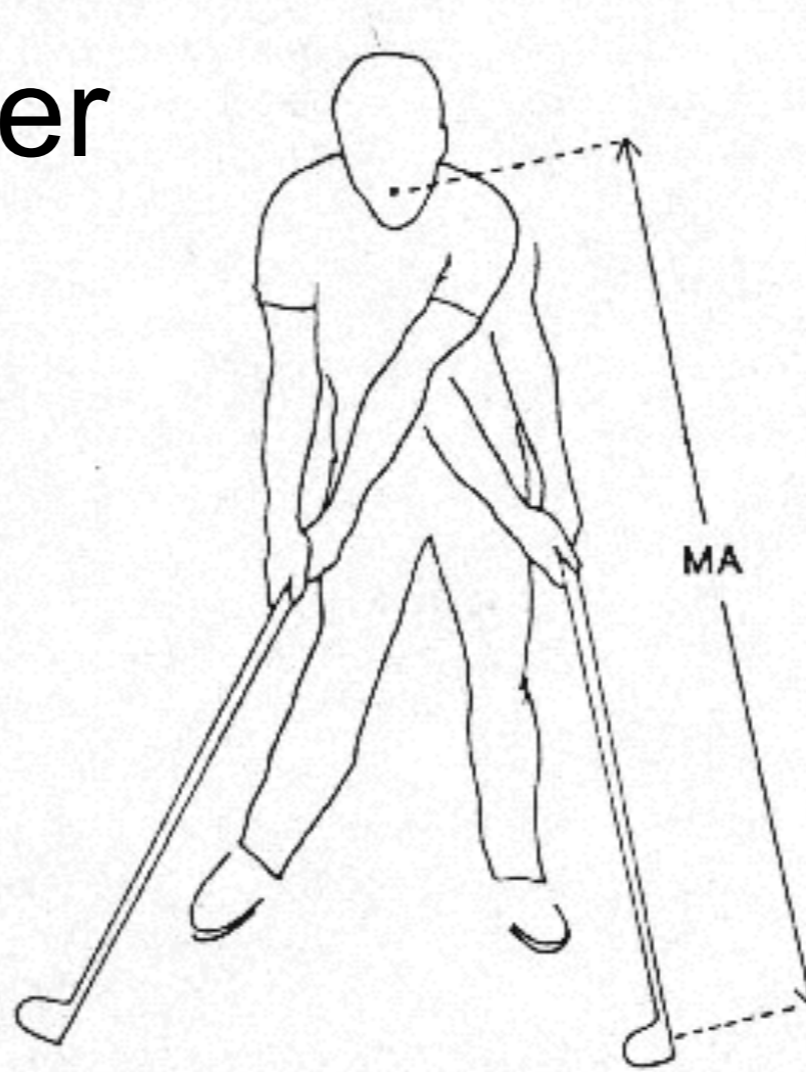

http://cogprints.org/625/1/jmb_87.html

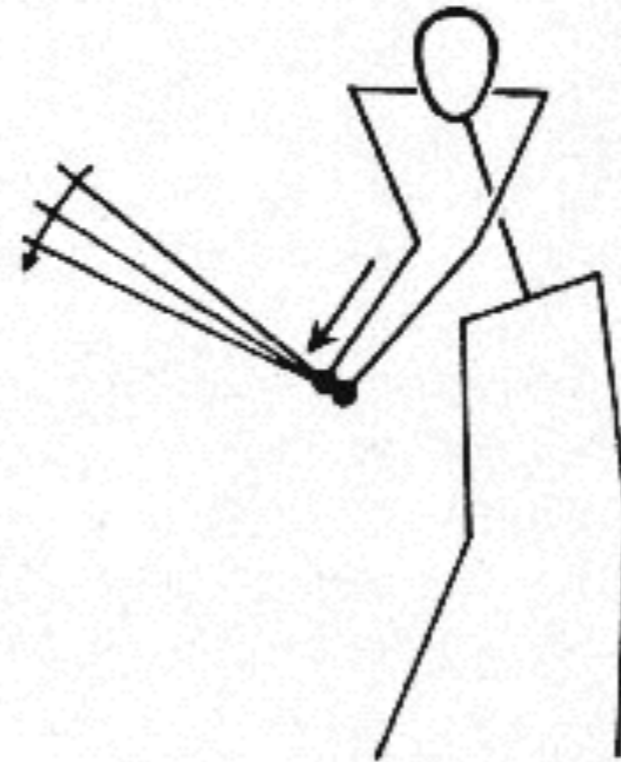
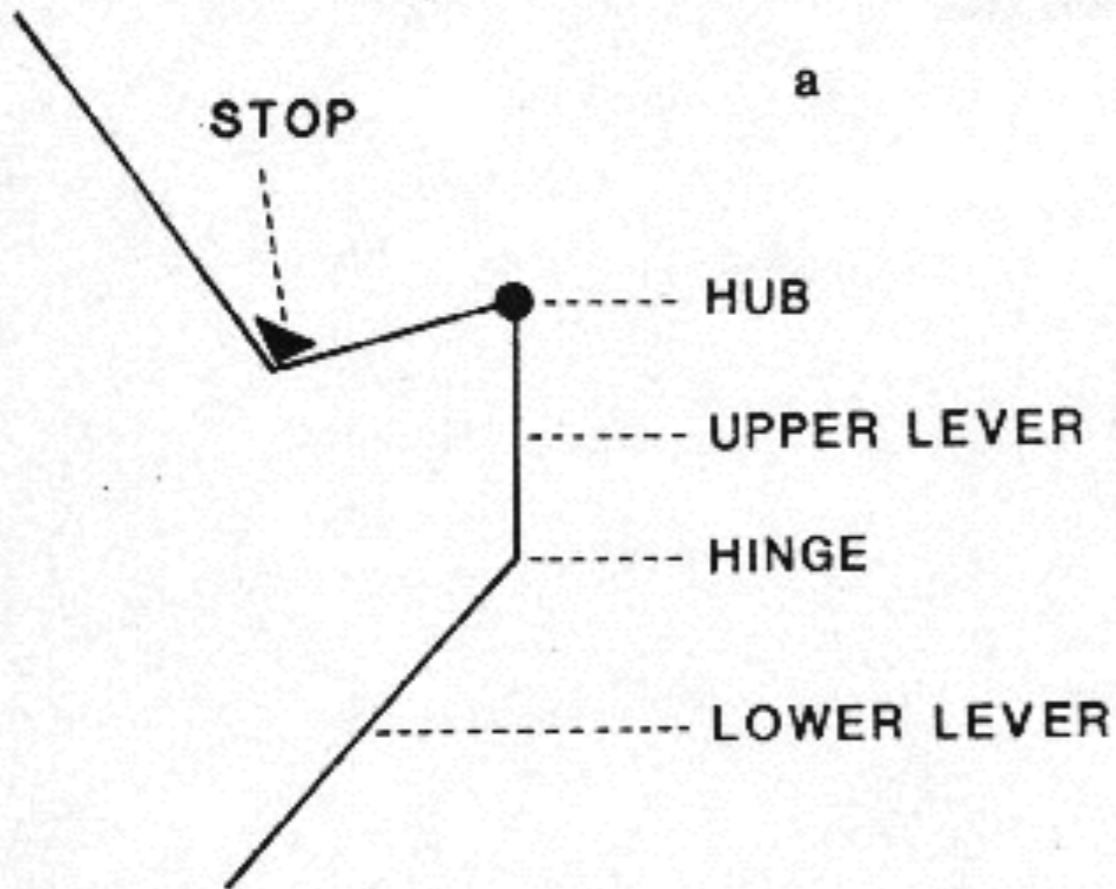

Die motorische Kette

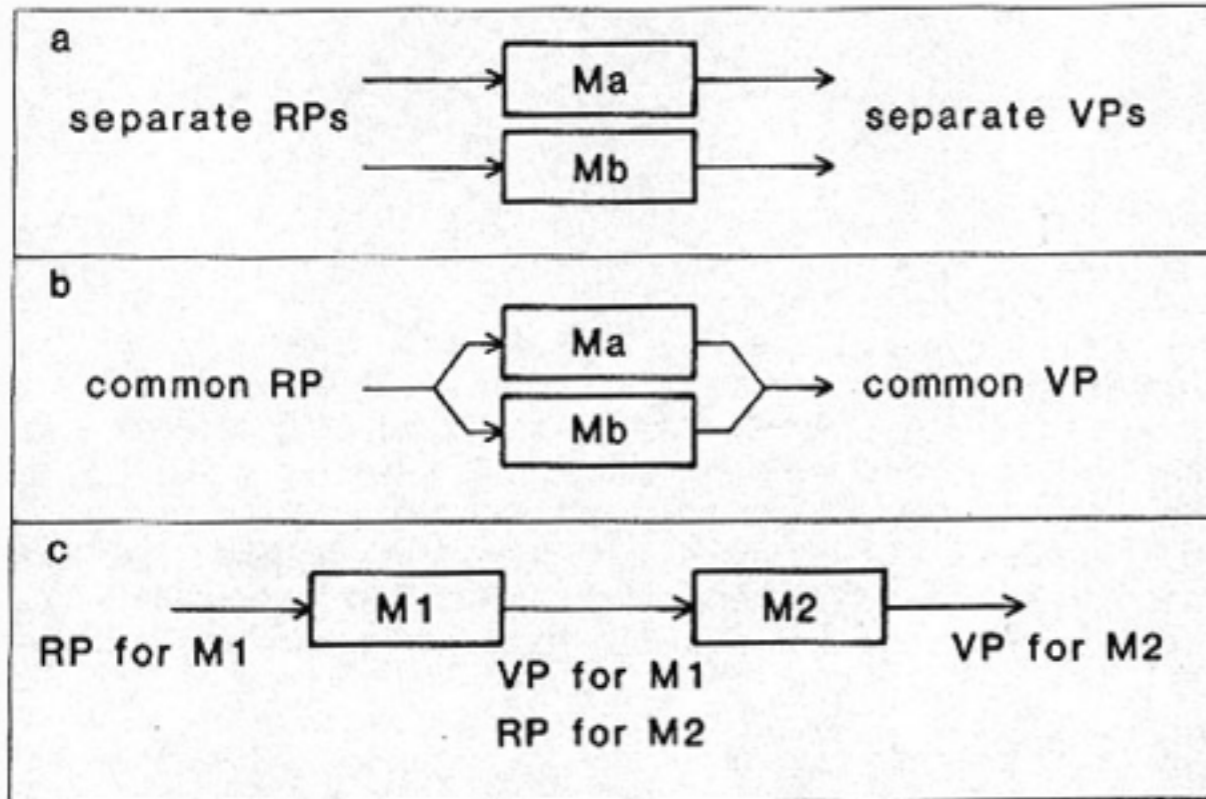
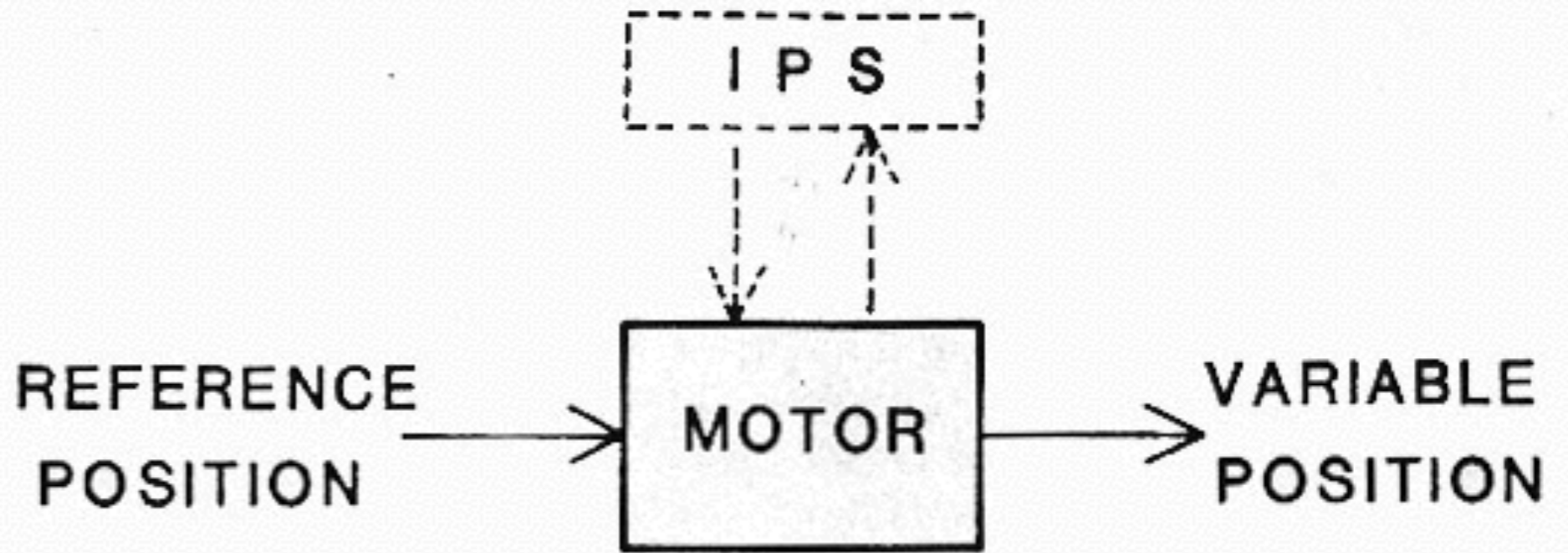

http://cogprints.org/625/1/jmb_87.html

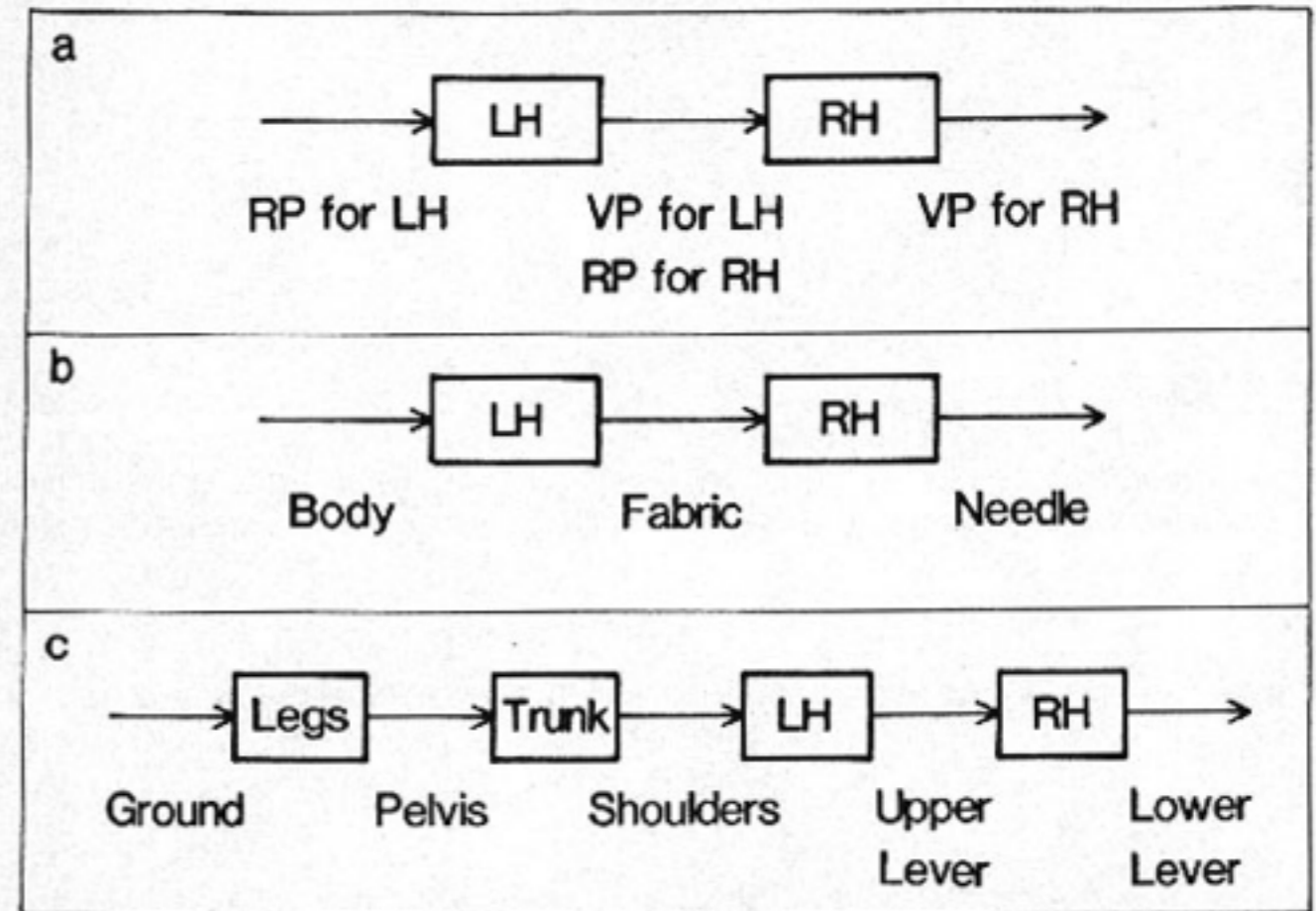

Photohelix: Beispiel für die Verwendung



Mini-Brainstorming

- Welche Handlungen im Alltag haben bzgl. der Hände eine
 - symmetrische Verteilung?
 - asymmetrische Verteilung?



<http://www.kanadaspezialist.com/2011/01/06/kanada-essen-alle-kanadier-ohne-gabeln-und-mit-den-ellenbogen-auf-dem-tisch/3633/>



<http://www.wdr5.de/sendungen/morgenecho/serien/serienueberblick/delikat100.html>