

# 2 Animation Techniques in Computer Game Programming

## 2.1 Computer game programming

## 2.2 Graphical Design of Game Characters with Flash

## 2.3 Game Physics

### Literature:

Chris Crawford: The Art of Computer Game Design,  
<http://www.vancouver.wsu.edu/fac/peabody/game-book/Coverpage.html>

Andrew Rollings, Dave Morris: Game Architecture and Design,  
New Riders 2004

Katie Salen, Eric Zimmerman: Rules of Play –  
Game Design Fundamentals, MIT Press 2004

# Outline (Changed!)

1. Example technology: Macromedia Flash & ActionScript
  - 1.1 Multimedia authoring tools - Example Macromedia Flash
  - 1.2 Elementary concepts of ActionScript
  - 1.3 Interaction in ActionScript
  - 1.4 Media classes in ActionScript
2. Animation techniques in computer game programming
  - 2.1 Computer games: History and classification
  - 2.2 Design and animation of game characters
  - 2.3 Game physics
3. Development process for multimedia projects
  - 3.1 Modeling of multimedia applications
  - 3.2 Classical models of the software development process
  - 3.3 Special aspects of multimedia development projects
  - 3.4 Example: The SMART process
  - 3.4 Agile development/Extreme Programming for multimedia projects
4. Overview on approaches to multimedia programming
  - 4.1 History of multimedia programming
  - 4.2 Squeak and Smalltalk: An alternative vision
  - 4.3 Frameworks for multimedia programming
  - 4.4 Summary and trends

# Why Computer Games in this Lecture?

- Computer game programming aims mostly at an immersive experience for the user
  - Same motivation is in the background for multimedia programming
- Game programming is a special case of multimedia programming
  - Uses highly interactive graphics, sound etc.
- Computer game programming is a huge market
- Macromedia Flash is an adequate platform for simple computer game programming
  - Considered too slow by most game programmers
  - But flexible, net-based, cross-platform, ...
  - The tutorials are about game programming

“A game designer does not create technology.  
A game designer creates an experience.”

Salen/Zimmerman

# SpaceWar: The First Computer Game (?)

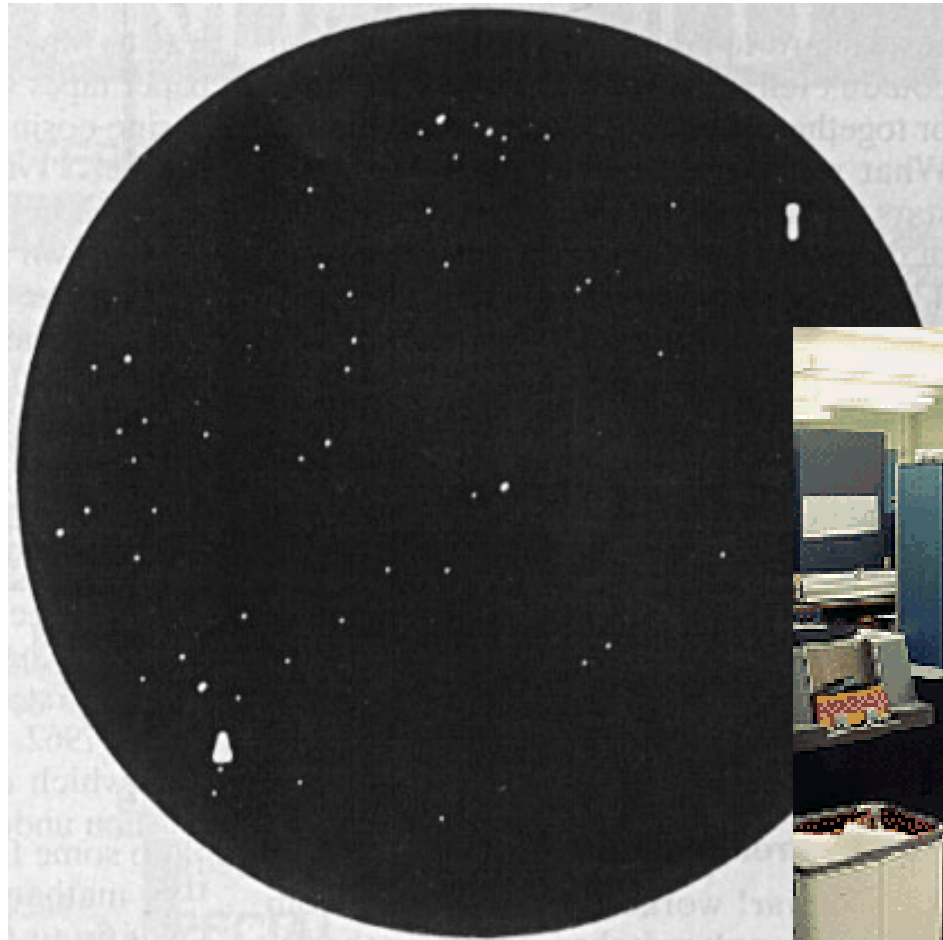

DEC PDP-1



# History of Computer Games

- 1962: First computer game “SpaceWar”
- Early 1970s: First commercial video game “Pong”
- Late 1970s: First text based adventure game “Adventure”
- 1980: Pac Man
- 1989: Nintendo Gameboy
- Early 1990s: Multiplayer action game “Doom”
- Mid 1990s: “Deep Blue” wins a chess game against world champion
- 1994: Sony Playstation
- 1998: Action game with level editor “Unreal Tournament”
- 2000: Microsoft XBox, Sony Playstation 2
- Current:
  - Mini games for mobile devices (phones, music players)
  - Multi-user online games (e.g. Ultima Online)

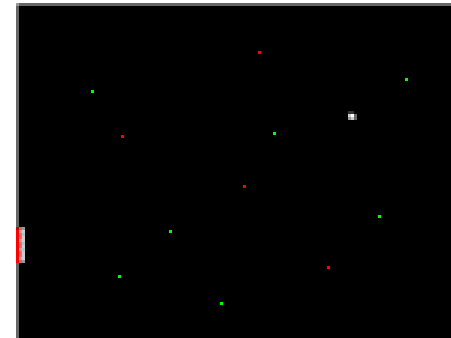

Pong



Doom



Unreal Tournament

(Partial) source: Elisabeth André

# Eras of Computer Games

- Era 1: Simply programmed games for specialists
  - High quality by competition & selection
- Era 2: Mass-market consoles
  - Quality partially problematic
  - “Platform games” (see section 2.2)
- Era 3: High-performance (3D) graphics technology
  - Presentation as important as game rules

Three eras according to Rollings/Morris

- Era 4: Online multiplayer games
- General observation:
  - Core game mechanics do not develop dramatically
  - Really new game ideas are rare
  - Game industry is conservative

# 2 Animation Techniques in Computer Game Programming

## 2.1 Computer game programming

## 2.2 Graphical Design of Game Characters with Flash

Creating a Story and a Hero

Optimizing Vector Graphics

Principles of Animation

## 2.3 Game Physics

Literature:

K. Besley et al.: Flash MX 2004 Games Most Wanted,  
Apress/Friends of ED 2004

Source code for all examples at [www.friendsofed.com](http://www.friendsofed.com)

# The Story and Situation for a New Game

“The sound of the screaming alarms aboard the space cruiser abruptly awoke Space Kid, our ultimate hero of the futuristic universe, from his cryogenic nap. When our hero investigated, it was obvious his worst fears were now true. His loyal sidekick, teddy, had been bear-napped from the comfort of his own sleep chamber.

Immediately Space Kid knew there could only be one ruthless and vile enemy capable of committing such an atrocity: his longtime arch nemesis, Lord Notaniceguy.

Armed only with his trusty ray gun, Super Kid changes course for Quexxon Sector-G. Although our brave hero is fully aware he’s falling for the bait in a trap, he must save Teddy.”



# Character Brainstorming (1)

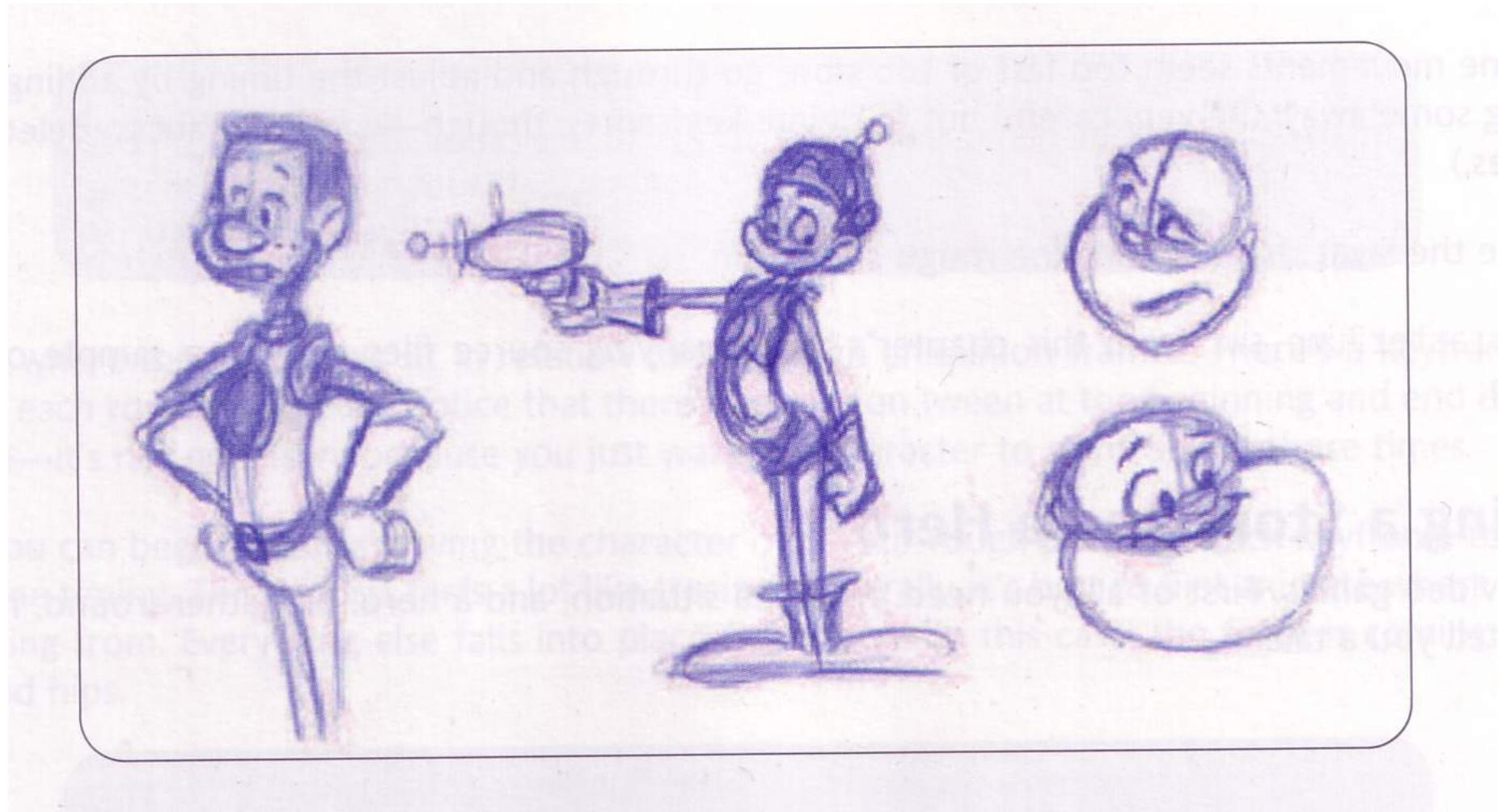

# Character Brainstorming (2)





# The Design Process

1. Create rough sketches of many different visual interpretations for the character (best with paper and pencil)
  - Brainstorming technique: Do *not* yet select!
2. Select among the gallery of characters according to compatibility with story, credibility, humour/seriousness, ...
3. Create rough sketches (***paper and pencil***) for the various animation sequences needed, e.g. run, jump, shoot, ...
  - Here usage of the authoring system can help already
4. Create optimized computer graphics for an “idle” animation.
5. Realize the animation sequences
  - Make sure that all sequences start and end with the idle position

# Rough Sketch for “Run” Animation



# The Enemies...

- Lord Notaniceguy's space slugs...

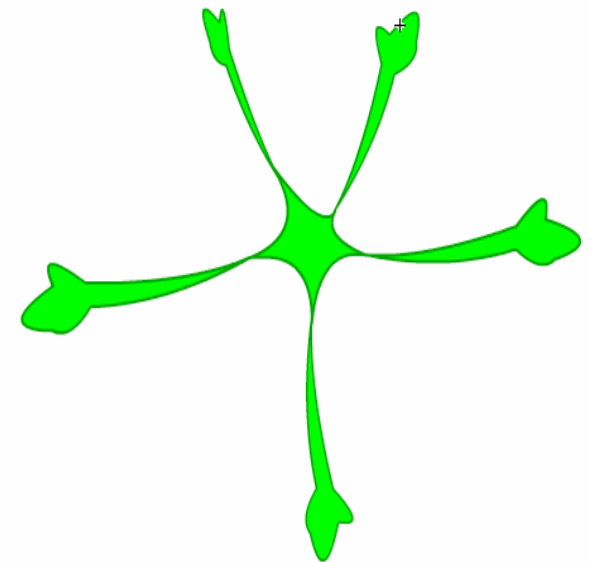

## 2 Animation Techniques in Computer Game Programming

### 2.1 Computer game programming

### 2.2 Graphical Design of Game Characters with Flash

Creating a Story and a Hero

Optimizing Vector Graphics

Principles of Animation

### 2.3 Game Physics

Literature:

K. Besley et al.: Flash MX 2004 Games Most Wanted,  
Apress/Friends of ED 2004

Source code for all examples at [www.friendsofed.com](http://www.friendsofed.com)

# Complexity of Polygon Drawings

- Normal drawings in vector graphics programs (like Flash)
  - Every line has a vector point on each end
  - Every time a line makes a sharp bend, at least one new vector point is needed
  - Every time two lines intersect, yet another vector point is created

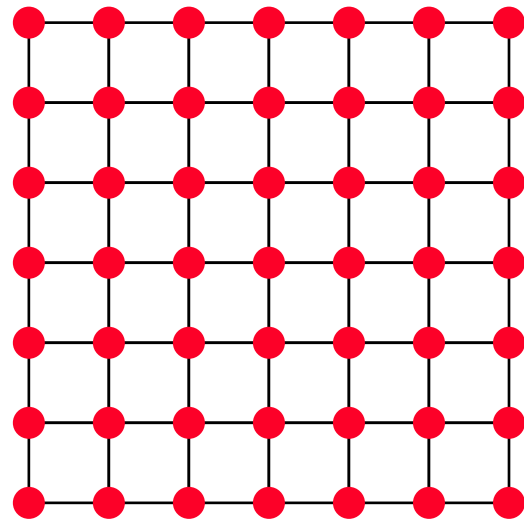

49 vector points



# Optimized Vector Drawings

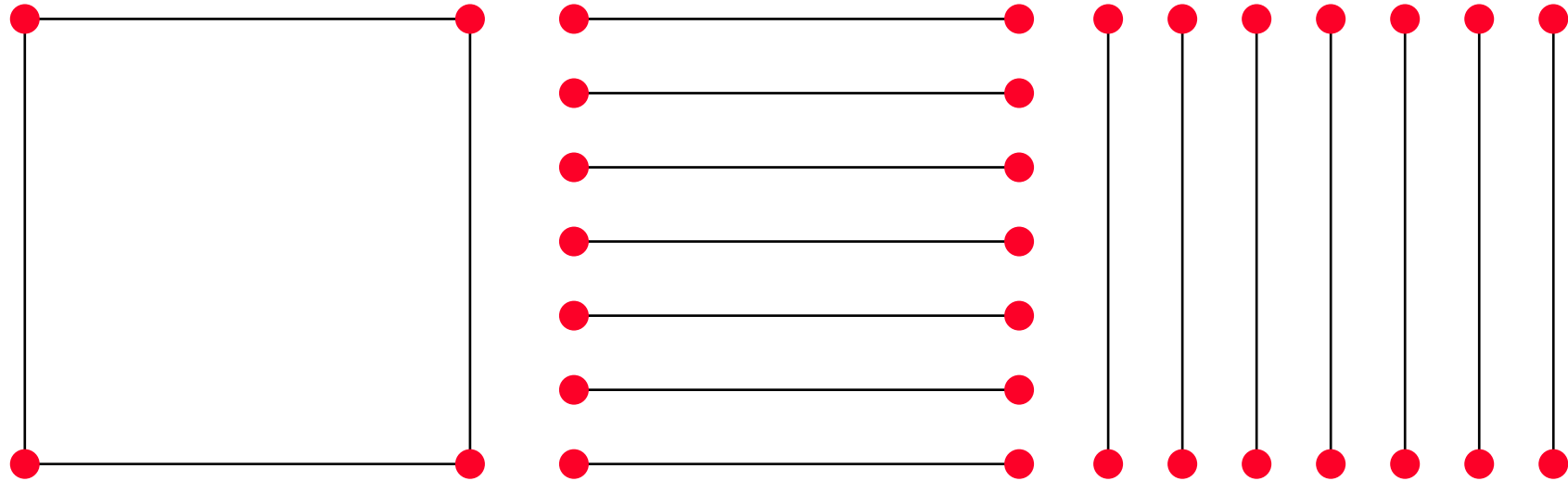

$$4 + 7 * 4 = 32 \text{ vector points}$$

Crosshair principle: avoid intersections

Flash:

Use separate layers to draw lines which intersect.  
Keep each layer free of intersections.

# Optimizing a Comic Character



# 2 Animation Techniques in Computer Game Programming

## 2.1 Computer game programming

## 2.2 Graphical Design of Game Characters with Flash

Creating a Story and a Hero

Optimizing Vector Graphics

Principles of Animation

## 2.3 Game Physics

Literature:

K. Besley et al.: Flash MX 2004 Games Most Wanted,  
Apress/Friends of ED 2004

Source code for all examples at [www.friendsofed.com](http://www.friendsofed.com)

# Principles of (2D-)Animation

- Keyframes
  - ... well known to Flash users
- Squash and Stretch
  - Shape of subject reacts to speed and force of movement
- Timing
  - Timing of movement: Gives animation a sense of weight and gravity
- Anticipation, Action, Reaction, Overlapping Action
  - Anticipation: Build up energy before a movement
  - Reaction: Don't simply stop, but show the process of stopping
  - Overlapping: Hierarchy of connected objects moves in a complex way
- Arcs
  - Every object follows a smooth arc of movement

# Animating a Bouncing Ball

- When the ball is going up, it is fighting the force of gravity and will therefore be slower than when it falls.
- On rise and fall, the ball is stretched to give the illusion it is travelling quickly. This effect should be more extreme on the fall.
- At the top of movement, the ball has a certain hang time.
- As soon as the ball hits the ground (and not before), it gets squashed horizontally.
- A shadow animation increases the optical illusion.
- Please note: These are exaggerations for the sake of a stronger illusion.

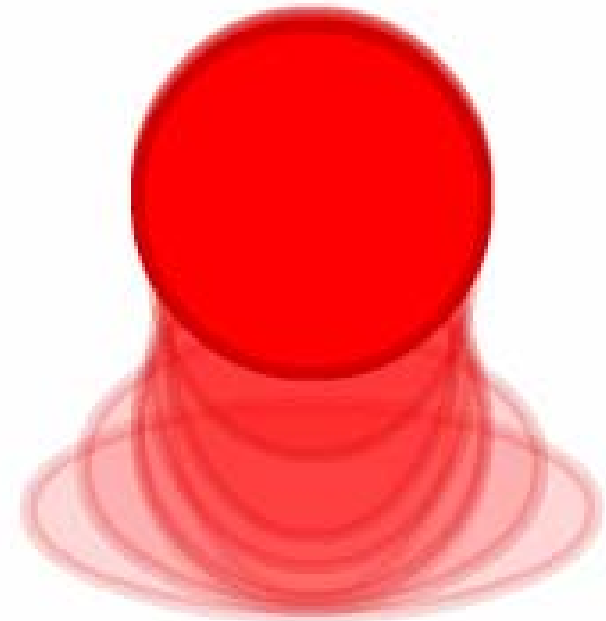

# An Animated Comic Character

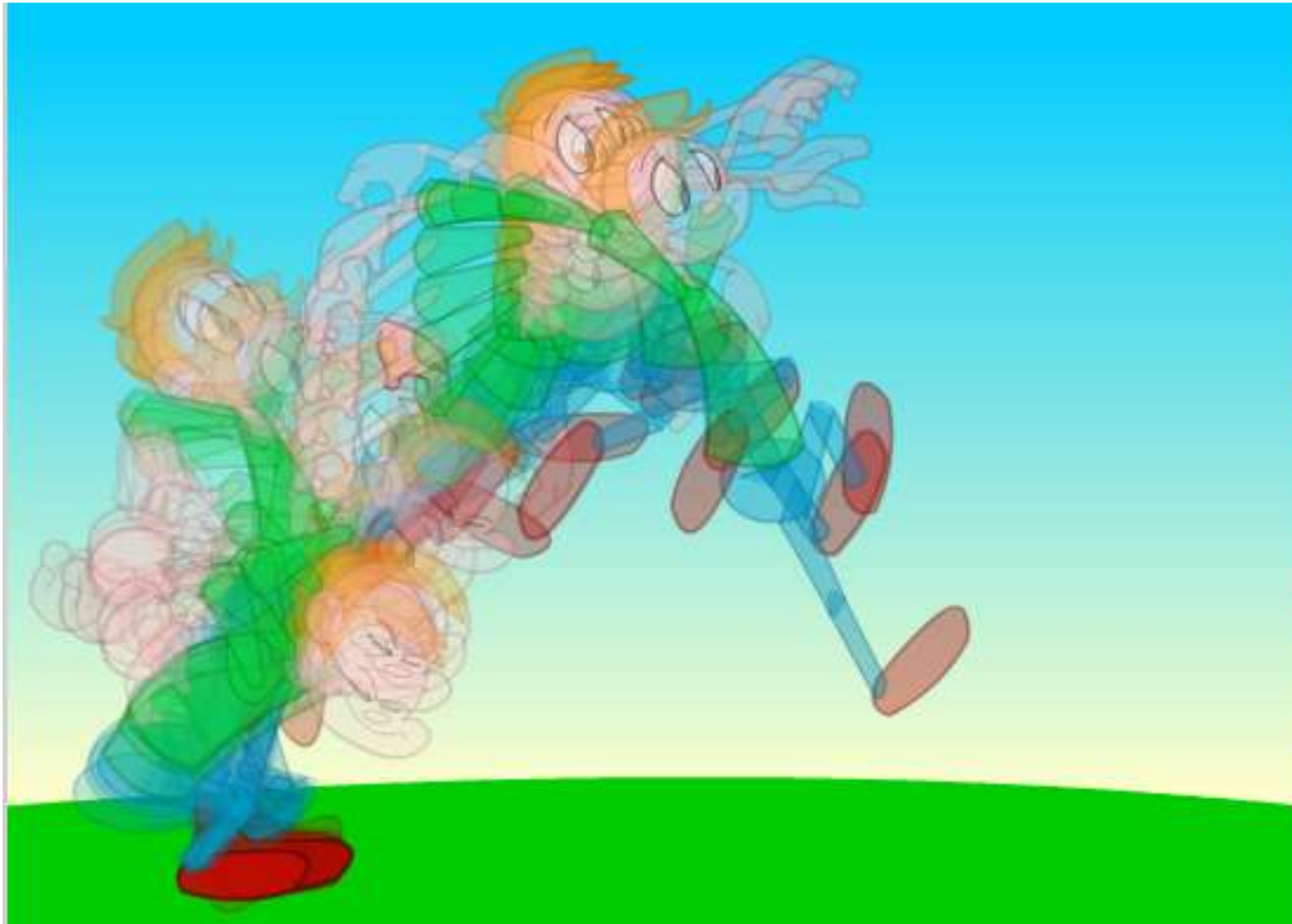

# Physics and Animation

- Jumping character:
  - Trajectory is computed by interactive program
  - $dx$  and  $dy$  values for updating the character's position
  - Jump may have different width and (not in the example game) height depending on user interaction
- Physics is controlled with code, not with animation
  - See next section!
- Consequence for movement animations (like jump):
  - Movements “as if staying on the ground”
  - Character design provides one central point for the character
    - » In the middle of the bottom
    - » Must be the same point across all animation phases
    - » Used to determine whether ground has been hit, whether we are falling off an edge, ...

# Continuity of Animation Sequences

Start and end picture of the animation sequences have to fit together

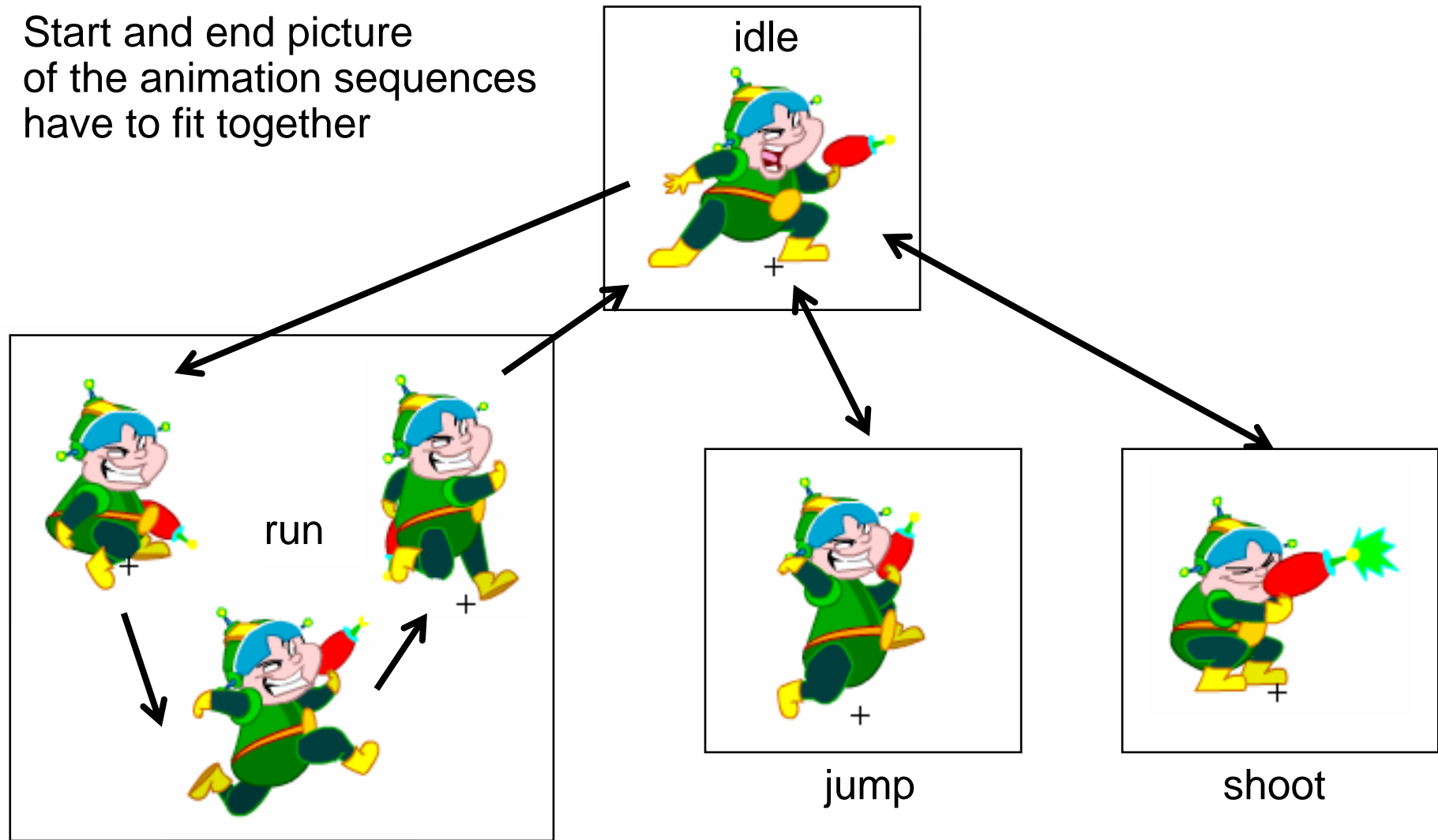



# Parallax/Multiplane Effect

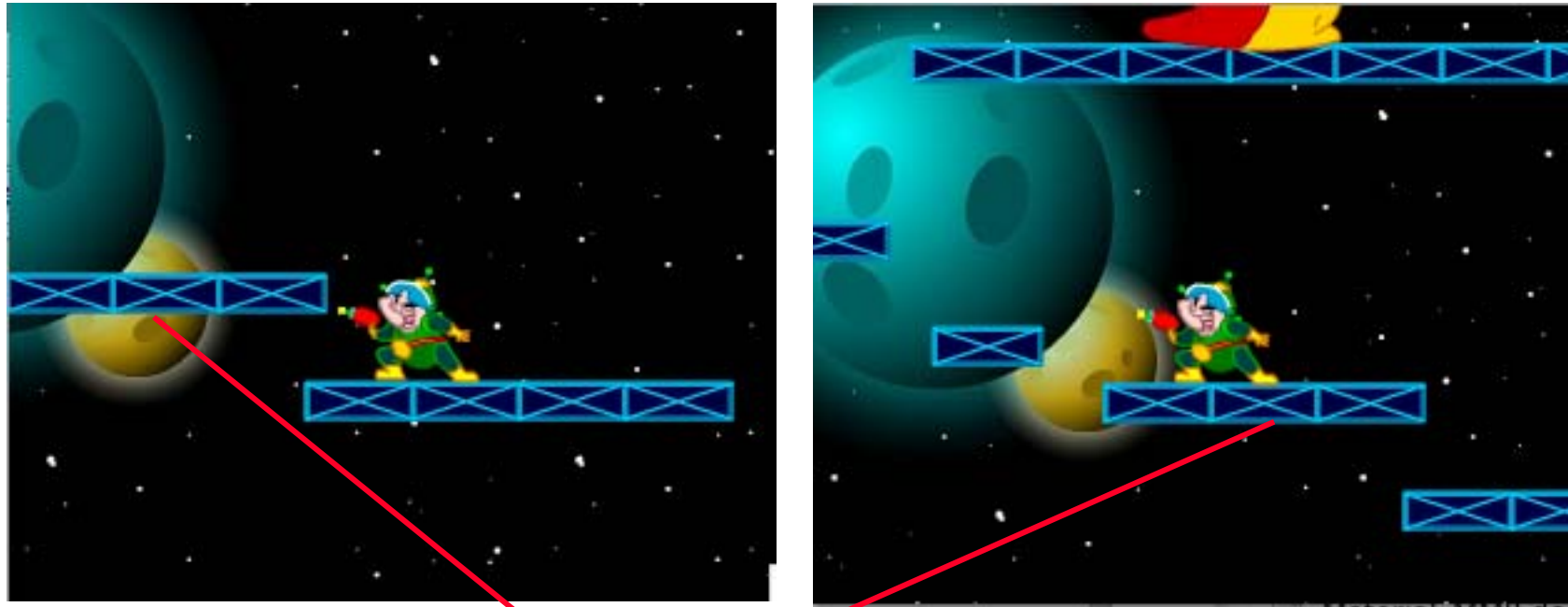

The same platform

- Parallax effect (game programming) / multiplane (animation):
  - Move the background at different (slower) rate than the foreground
  - Creates a sensation of depth

## 2 Animation Techniques in Computer Game Programming

2.1 Computer game programming

2.2 Graphical Design of Game Characters with Flash

Creating a Story and a Hero

Optimizing Vector Graphics

Principles of Animation

2.3 Game Physics

Literature:

K. Besley et al.: Flash MX 2004 Games Most Wanted,  
Apress/Friends of ED 2004

Source code for all examples at [www.friendsofed.com](http://www.friendsofed.com)

# Billiard-Game Physics

- Typical problem:
  - Two round objects moving at different speeds and angles hitting each other
  - How to determine resulting speeds and directions?
- Example used here:
  - Billiard game (of course)



# Ball-to-Wall Bounces, Simple Version

```
BALL_DIAMETER = 20;
BALL_RADIUS = BALL_DIAMETER/2;
TOP = table_mc._y-table_mc._height/2+BALL_RADIUS;
BOTTOM = table_mc._y+table_mc._height/2-BALL_RADIUS;
LEFT = table_mc._x-table_mc._width/2+BALL_RADIUS;
RIGHT = table_mc._x+table_mc._width/2-BALL_RADIUS;
BOUNCE = -1;
whiteBall_mc.vx = Math.random()*5+2; // horizontal velocity
whiteBall_mc.vy = Math.random()*5+2; // vertical velocity
whiteBall_mc.onEnterFrame = ballMove;
function ballMove() {
    this._x += this.vx;
    this._y += this.vy;
    if (this._x>RIGHT) {
        this._x = RIGHT; this.vx *= BOUNCE;
    } else if (this._x<LEFT) {
        this._x = LEFT; this.vx *= BOUNCE;
    }
    if (this._y>BOTTOM) {
        this._y = BOTTOM; this.vy *= BOUNCE;
    } else if (this._y<TOP) {
        this._y = TOP; this.vy *= BOUNCE;
    }
}
```

# Bounce and Friction

- Bouncing always takes away some part of energy
  - Set BOUNCE to factor smaller than 1
- The surface of the table always absorbs some part of the energy and slows down the ball
  - Reduce velocity by some factor each frame
  - Constant DAMP

```
BALL_DIAMETER = ...
BOUNCE = -0.6;
DAMP = 0.99;
...
function ballMove() {
    this.vx *= DAMP;
    this.vy *= DAMP;
    this._x += this.vx;
    this._y += this.vy;
    if (this._x > RIGHT) {
        ...
    }
    ...
}
```

# Minimum Speed

```
MINSPEED = .1;  
...  
function ballMove() {  
    ...  
    this.speed = Math.sqrt(this.vx*this.vx+this.vy*this.vy);  
    if (this.speed<MINSPEED) {  
        this.vx = 0;  
        this.vy = 0;  
        delete this.onEnterFrame;  
    }  
}
```

- Needed for this: Effective speed out of x and y velocities

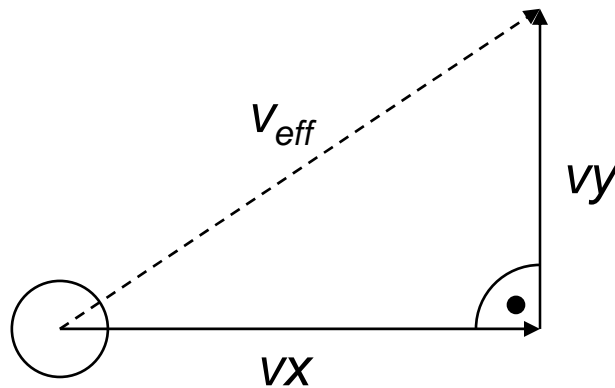

$$v_{eff} = \sqrt{vx^2 + vy^2}$$

# Cue Stick, Aiming

```
stick_mc.onEnterFrame = aim;  
function aim() {  
    var dx = whiteBall_mc._x-_xmouse;  
    var dy = whiteBall_mc._y-_ymouse;  
    angle = Math.atan2(dy, dx);  
    this._rotation = angle*180/Math.PI;  
    this._x = _xmouse;  
    this._y = _ymouse;  
}
```

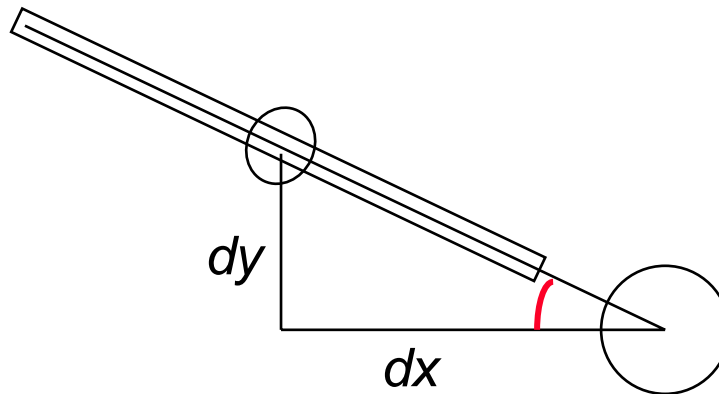

# Shooting

```
function shoot() {  
  this._x = _xmouse;  
  this._y = _ymouse;  
  this.vx = this._x-this.olddx;  
  this.vy = this._y-this.oldy;  
  this.olddx = this._x;  
  this.oldy = this._y;  
  var dx = whiteBall_mc._x-this._x;  
  var dy = whiteBall_mc._y-this._y;  
  var dist = Math.sqrt(dx*dx+dy*dy);  
  if (dist<110) {  
    whiteBall_mc.vx = this.vx;  
    whiteBall_mc.vy = this.vy;  
    whiteBall_mc.onEnterFrame  
      = ballMove;  
    this.onEnterFrame = aim;  
  }  
}
```

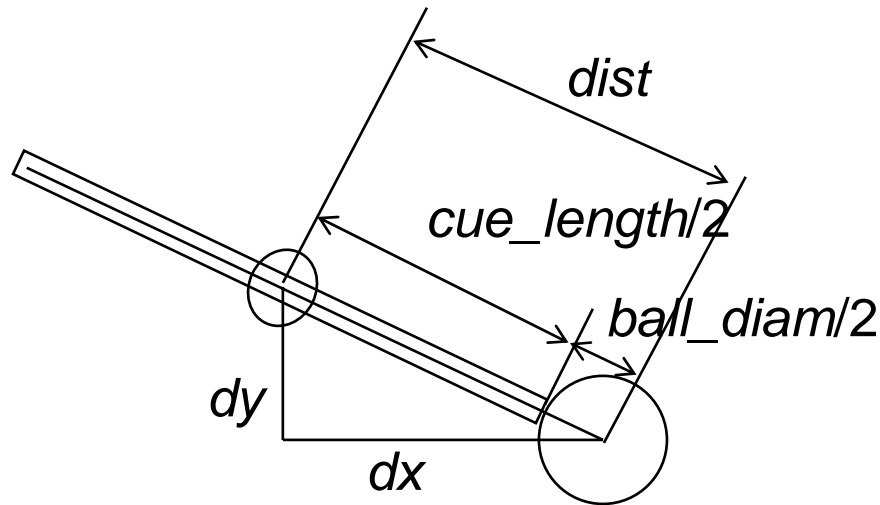

$$dist = \sqrt{dx^2 + dy^2}$$

cue\_length = 200  
ball\_diam = 20



# Switching Between Modes of Objects

- The ball switches between two states:
  - “moving”: `onEnterFrame` handler assigned to `ballMove()`
  - “standing still”: `onEnterFrame` handler deleted
- The cue stick switches between two states:
  - “shooting”: `onEnterFrame` handler assigned to `shoot()`
  - “aiming”: `onEnterFrame` handler assigned to `aim()` (default)

```
stick_mc.onEnterFrame = aim;
onMouseDown = function () {
    stick_mc.onEnterFrame = shoot;
};
onMouseUp = function () {
    stick_mc.onEnterFrame = aim;
};
```

# Little Tricks for Shooting...

- It is not sufficient to move the stick with the mouse during shooting at constant angle. Instead, the cue stick shall move back and forth on the line which was defined when aiming.

```
this._x = whiteBall_mc._x-Math.cos(angle)*dist;  
this._y = whiteBall_mc._y-Math.sin(angle)*dist;
```

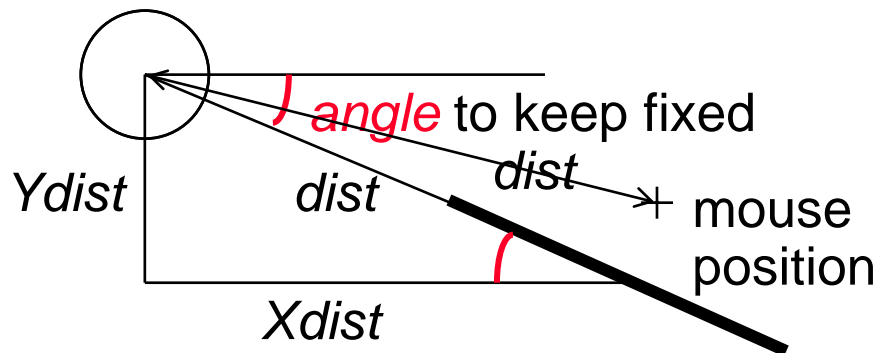

$$\sin angle = \frac{Ydist}{dist}$$
$$\cos angle = \frac{Xdist}{dist}$$

- At mouse down, add a test whether the stick is already in collision with the ball (which does not make sense):

```
onMouseDown = function () { ... Compute distance dist  
    if (dist>110)  
        stick_mc.onEnterFrame = shoot;  
};
```

# Shooting, Final Version

```
function shoot() {
  var dx = whiteBall_mc._x-_xmouse;
  var dy = whiteBall_mc._y-_ymouse;
  var dist = Math.sqrt(dx*dx+dy*dy);
  this._x = whiteBall_mc._x-Math.cos(angle)*dist;
  this._y = whiteBall_mc._y-Math.sin(angle)*dist;
  this.vx = this._x-this.oldx;
  this.vy = this._y-this.oldy;
  this.oldx = this._x;
  this.oldy = this._y;
  var dx = whiteBall_mc._x-this._x;
  var dy = whiteBall_mc._y-this._y;
  var dist = Math.sqrt(dx*dx+dy*dy);
  if (dist<110) {
    whiteBall_mc.vx = this.vx;
    whiteBall_mc.vy = this.vy;
    whiteBall_mc.onEnterFrame = ballMove;
    this.onEnterFrame = aim;
  }
}
```

# Collision Detection Between Balls

- Two balls are able to collide.
  - Collision detection as a separate entity from the two balls
  - E.g. `onEnterFrame` handler on timeline

```
onEnterFrame = checkCollision;  
function checkCollision() {  
    var dx = redBall_mc._x-whiteBall_mc._x;  
    var dy = redBall_mc._y-whiteBall_mc._y;  
    var dist = Math.sqrt(dx*dx+dy*dy);  
    if(dist<BALL_DIAMETER){  
        ... collision detected ...  
    }  
}
```

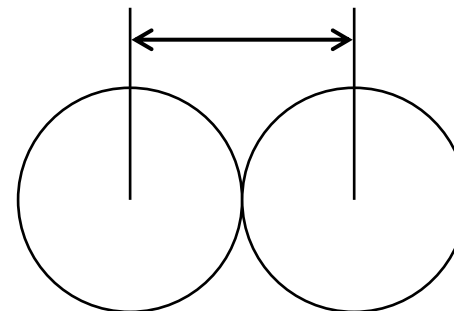

# Physics: Speed, Velocity, Mass, Momentum

- *Speed:*
  - How fast is something moving (length/time)
- *Velocity:*
  - Vector describing movement: *speed + direction*
- *Mass:*
  - Basic property of object, depending on its material, leads under gravity to its *weight*
- *Momentum (dt. Impuls):*
  - Mass x Velocity
- *Principle of Conservation of Momentum (dt. Impulserhaltung):*
  - Total momentum of the two objects before the collision is equal to the total momentum after the collision.

# A Simple Case of Collision

- Two balls collide “head on”
- Balls have same size and same mass

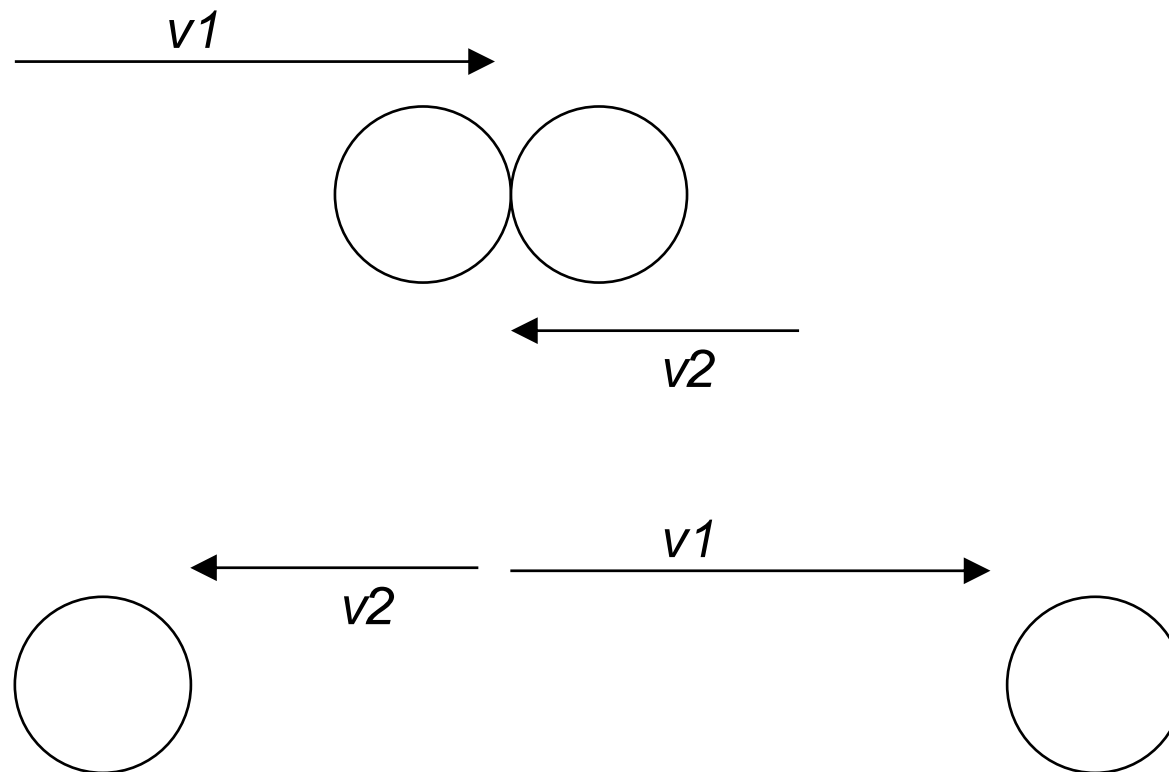

# Placing Balls At Collision Time

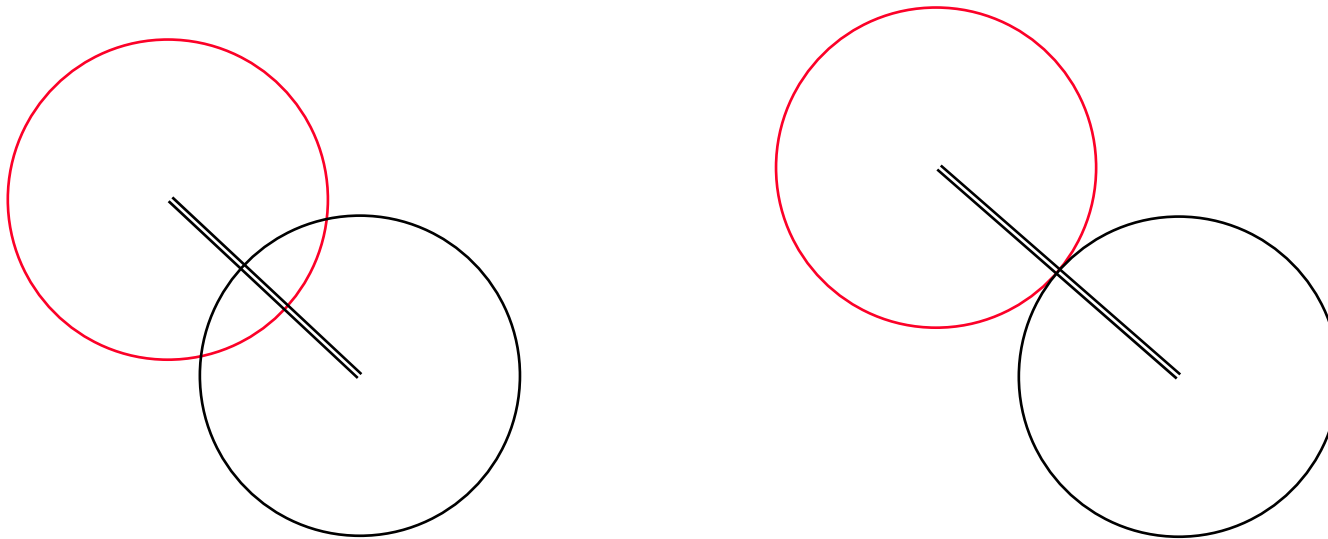

This is a simplification compared to the actual physical laws.

# Physics of Collision, Step 1

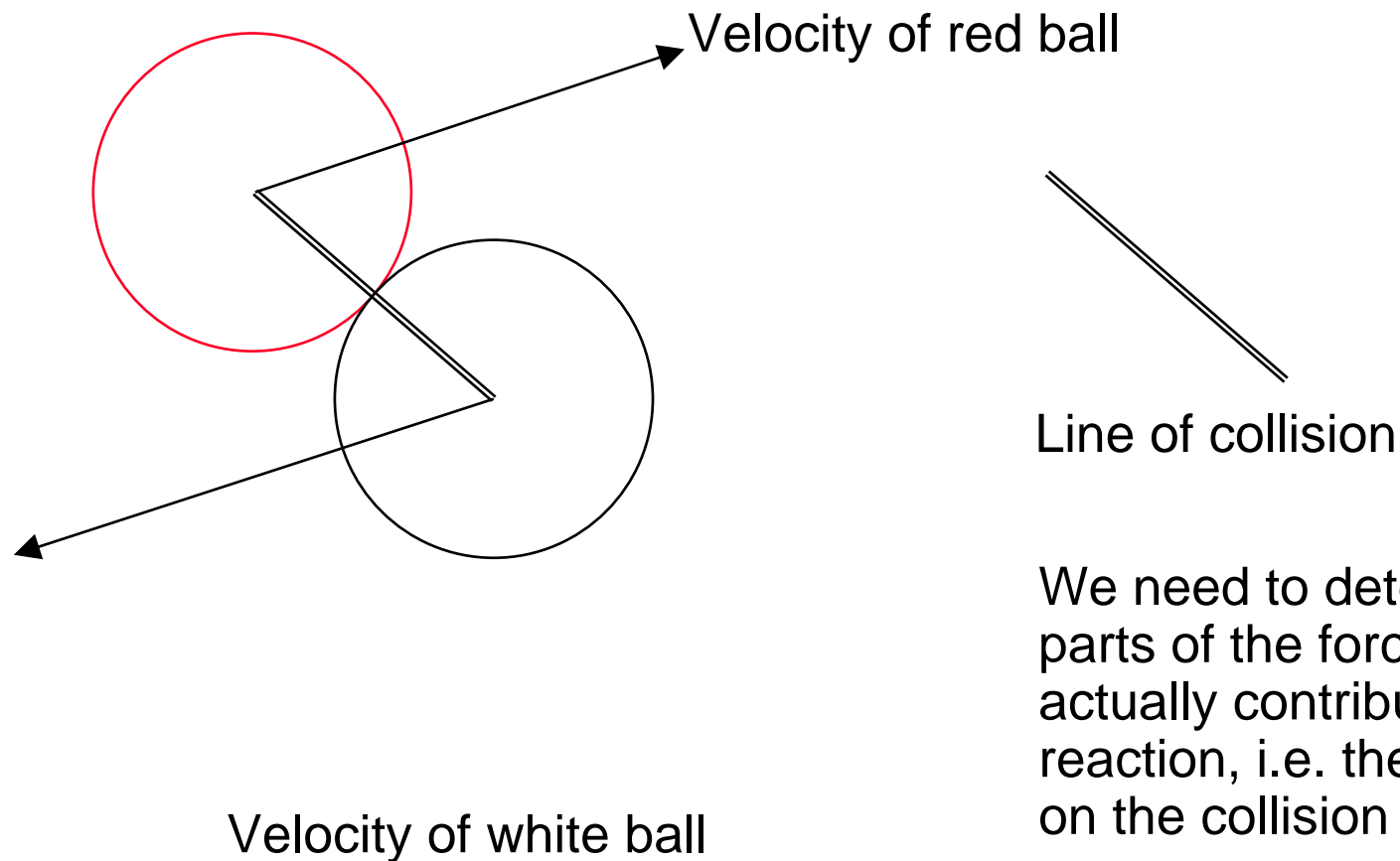



# Physics of Collision, Step 2

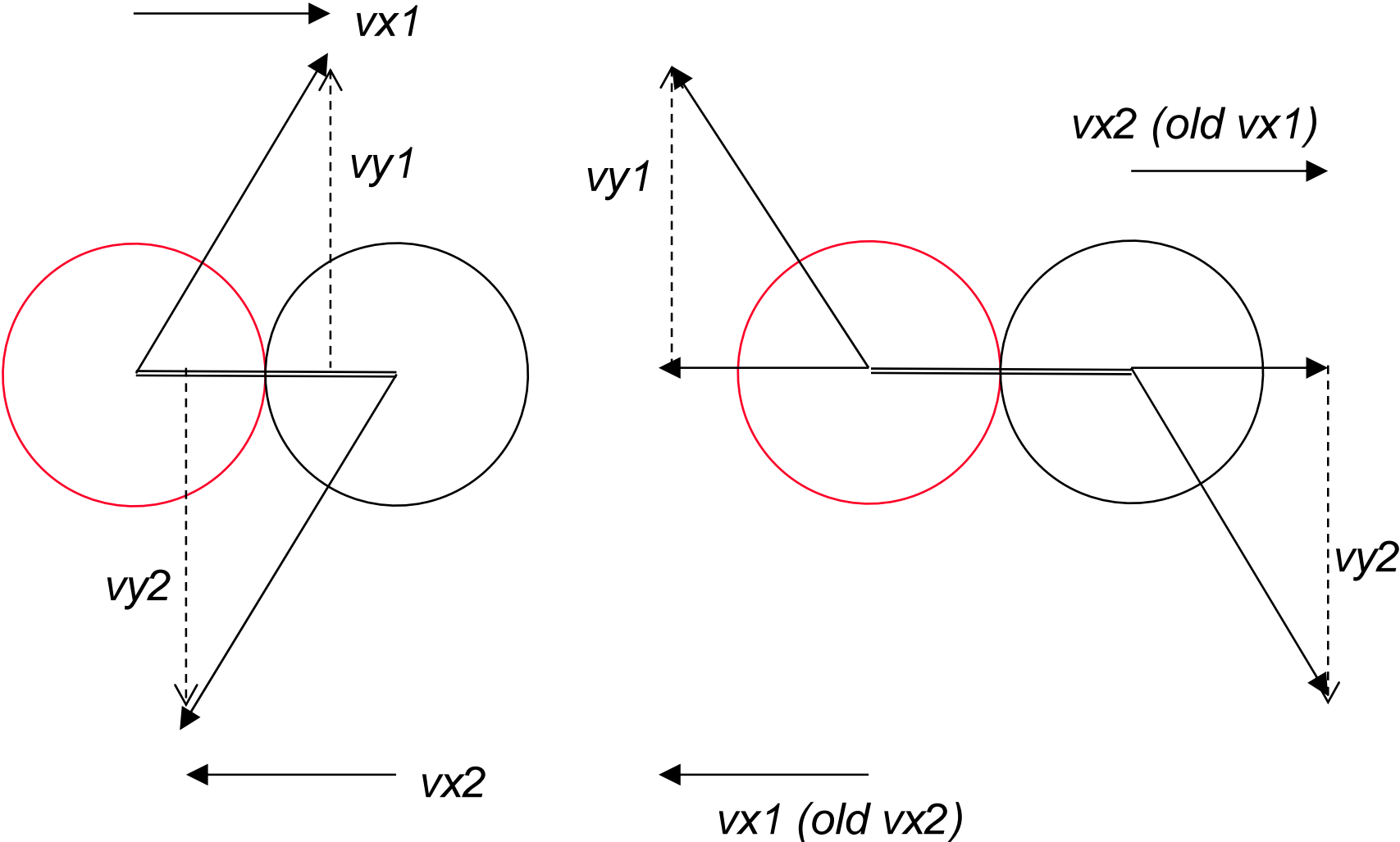

# Physics of Collision, Step 3

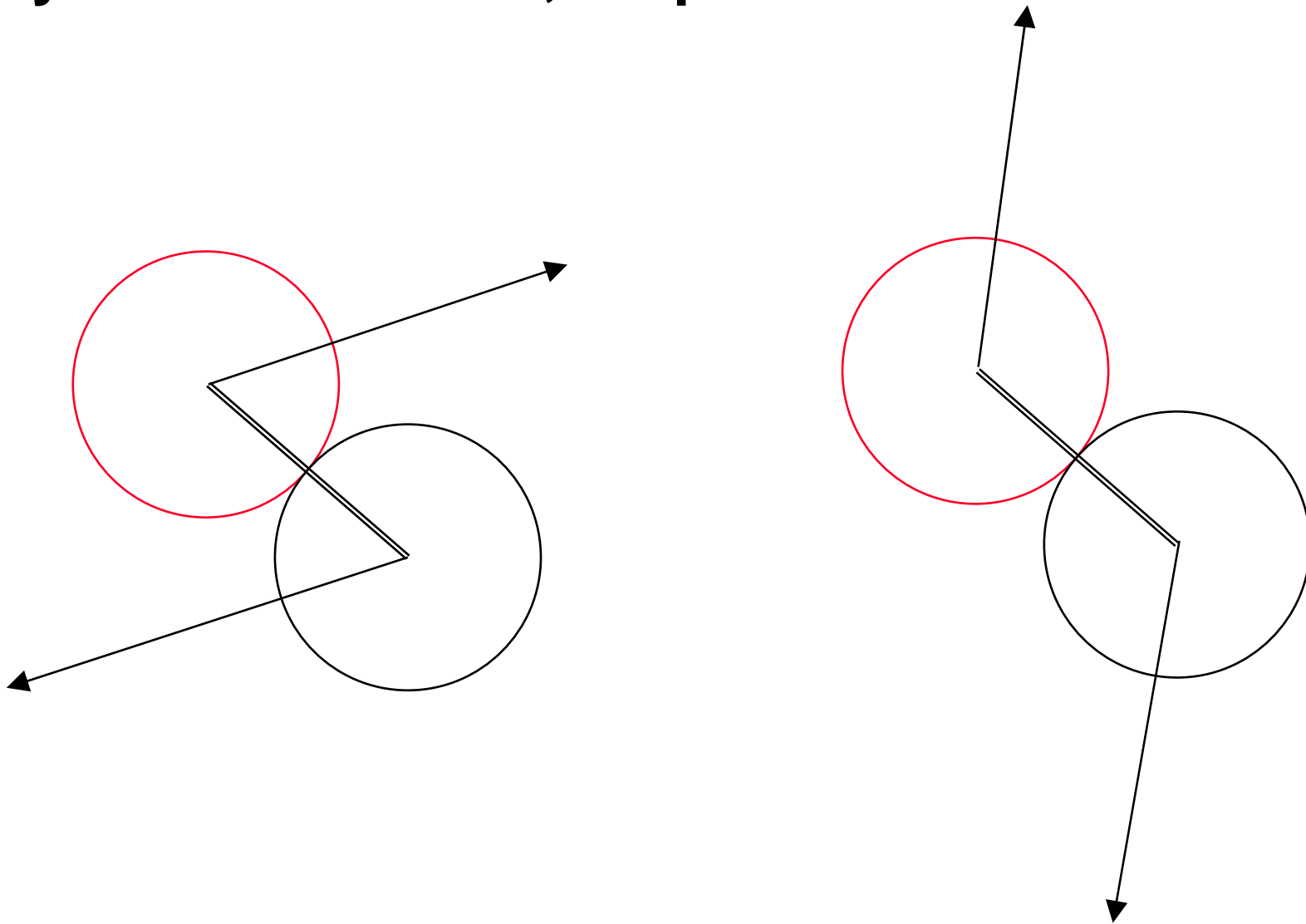

# Computing Step 1

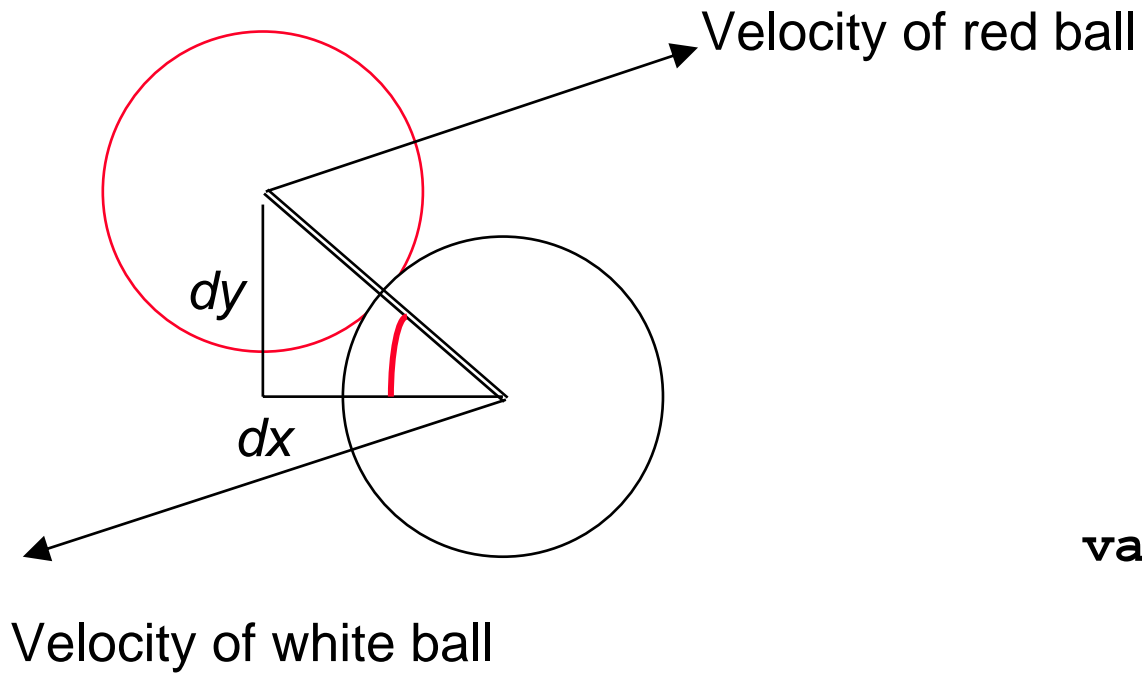

```
var angle =  
    Math.atan2(dy,dx);
```

# Computing Step 2, Part 1

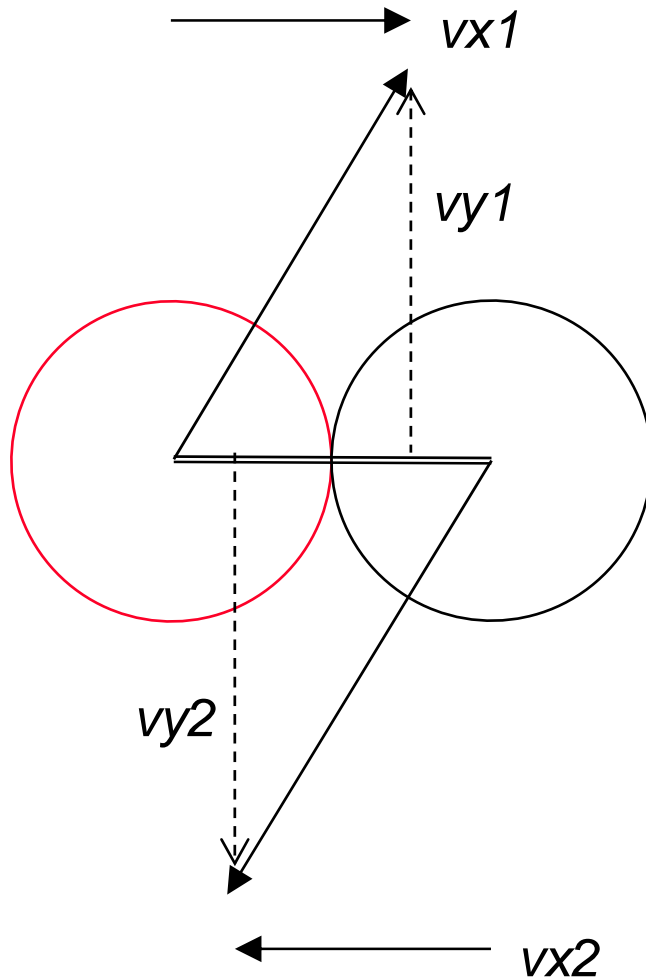

Counterclockwise rotation  
of vector  $(x, y)$ :

$$x1 = \cos(\alpha) \cdot x + \sin(\alpha) \cdot y$$

$$y1 = \cos(\alpha) \cdot y - \sin(\alpha) \cdot x$$

```
var angle =  
    Math.atan2(dy, dx);  
  
var cosa = Math.cos(angle);  
var sina = Math.sin(angle);  
var vx1 =  
    cosa*redBall_mc.vx +  
    sina*redBall_mc.vy;  
var vy1 =  
    cosa*redBall_mc.vy -  
    sina*redBall_mc.vx;  
... vx2, vy2
```

# Computing Step 2, Part 2

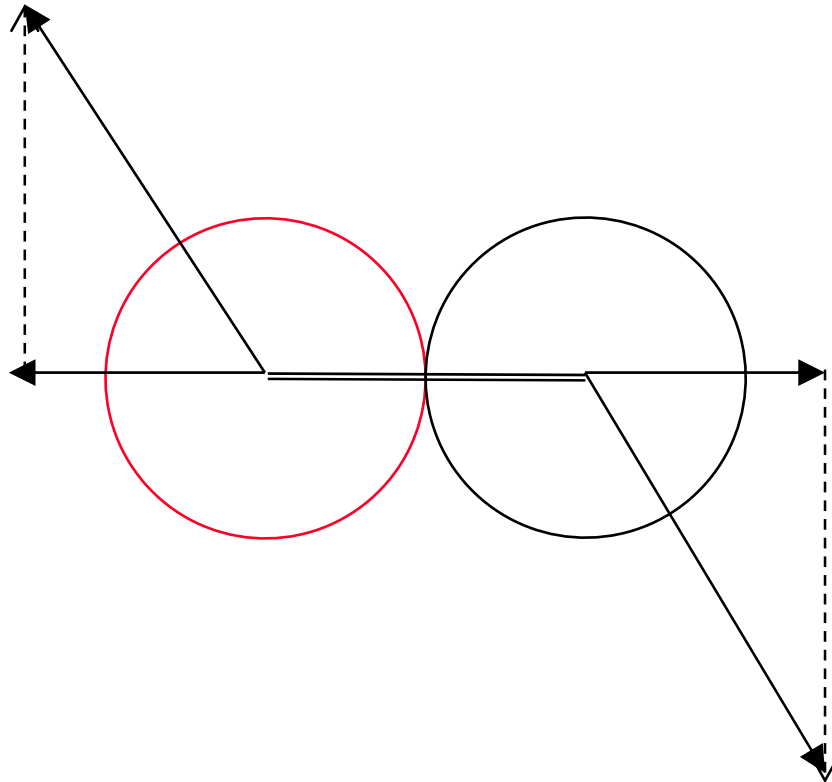

```
...  
var tempvx = vx1;  
vx2 = vx1;  
vx1 = tempvx;
```

## Computing Step 3

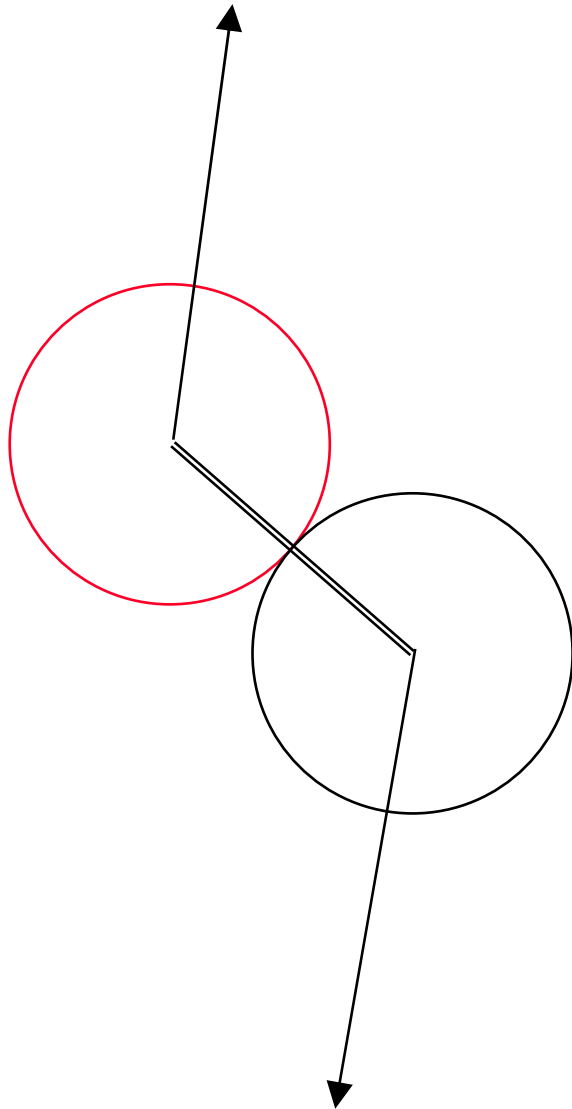

Clockwise rotation  
of vector  $(x, y)$ :

$$x1 = \cos(\alpha) \cdot x - \sin(\alpha) \cdot y$$

$$y1 = \cos(\alpha) \cdot y + \sin(\alpha) \cdot x$$

```
redBall_mc.vx =  
    cosa*vx1 - sina*vy1;  
redBall_mc.vy =  
    cosa*vy1 + sina*vx1;  
whiteBall_mc.vx =  
    cosa*vx2 - sina*vy2;  
whiteBall_mc.vy =  
    cosa*vy2 + sina*vx2;  
  
redBall_mc.onEnterFrame =  
    ballMove;  
whiteBall_mc.onEnterFrame =  
    ballMove;
```