

11 Web Radio, Web TV and IPTV

11.1 Web Radio

11.2 Web TV

11.3 Audio and Video Streaming over IP

Literature:

Chris Priestman: Web Radio, Focal Press 2002

A British Radio Pioneer, 1924

John Reith, *Broadcasting over Britain*, 1924

Later Director General of BBC

“We are missing infinitely more than we are receiving ... Thought is probably permanent, and a means may be found to ally thought with ether direct and to broadcast and communicate thought without the intervention of the senses or any mechanical device, in the same manner as a receiving set is today tuned to the wave-length of a transmitter so that there may be a free passage between them.”

- “free passage between them” clearly indicates bi-directionality!

What Is Web Radio?

- Web radio is about *live audio streams*
 - Which may be composed from archives!
 - Which may be made accessible in archives as well!
- Audio content is delivered to large audience, in identical form for all listeners
 - No individual streams, no download (no “on demand” service)
- “Simulcast”: Traditionally produced radio program is transmitted in Internet simultaneously

Historic Parallels between Radio and Web Radio

- Technical problems with sound quality
 - Early radio transmission (1920's) were of poor sound quality, short wave radio still is today
 - Early radio transmission over the Internet was of poor sound quality, but the situation is improving rapidly
- The ever-repeated threat situation between new and old media
 - Early radio was considered a threat to news and entertainment industries
 - » Like TV for movie industry
 - Web radio as a threat for traditional radio, news, entertainment?
 - Lesson from history: Media grow into complementary, synergetic situation (“Riepl'sches Gesetz”)
- Driving force are amateurs
 - Early radio program development, at least in the U.S., driven by amateur stations
 - Exactly identical situation for Web radio today
- Private/public/commercial, funding models, ...

Radio and Democracy

- Bertolt Brecht, 1930:

“Radio could be the most wonderful public communication system imaginable, a gigantic system of channels – could be, that is, if it were capable not only of transmitting but of receiving, of making listeners hear but also speak, not of isolating them but connecting them.”

 - Bertolt Brecht even conducted amateur experiments with the new medium “radio” himself
- Radio, if not restricted by monopolies, is a decentralized, democratic medium
 - Web radio may be the way to remove the constraints (frequency shortage) which have led to monopolies
 - Web radio removes spatial constraints of radio (global medium)
- “Vertical” organization (centralized, hierarchic, top-down) vs. “horizontal” organization (decentralized, peer-to-peer, bottom-up)
 - Radio started as a horizontally organized experiment

Types of Web Radio Stations/Programmes

- According to traditional sectors of the radio industry:
(Lewis/Booth: *The Invisible Medium*)
- Sector 1: Early European Model
 - Public service and state radio as governmental organizations, often monopolies
 - » Web radio as additional distribution channel, as platform for global services, for cross-media effects with other parts of Web presence (information, shop)
- Sector 2: American Model
 - Commercial enterprises funded through advertising
 - » Web radio as platform for advertising (also for the traditional broadcast)
 - » Web radio as additional source of revenue (through e-Commerce)
- Sector 3: Alternative
 - *Community stations (free radio)*, see www.amarc.org
 - *Underground stations*
 - Web radio as a cheap technology, avoiding also many licensing problems

Experience of Radio Listening

- Experience formed by receiver technology:
 - 1930s: Large valve radio as important “furniture” in the living room
 - 1950s onwards: TV taking over as centre of living room
 - 1960s: Transistor radios make radio receivers portable, enable car receivers
 - 1970s: Stereo high-fidelity systems change expectations of audience
 - Today: Mainly background music and car receivers
- Market niche for Web radio:
 - High-quality terrestrial radio (FM) has limited local range
- Competitors for Web radio:
 - Global-range radio of good quality (Satellite radio, Digital Radio Mondiale)
- Web Radio experience, integrated into daily life:
 - Computer as playback device?
 - Must seamlessly integrate with existing devices
 - » ...or be completely stand-alone and innovative
 - Smartphones, speaker systems for portable players, specialized devices

Physical Devices for Internet Radio

- A radio receiver should look like one, even if it is Web radio...
 - Standalone Internet radio devices
- Product pioneers around 2000:
 - Kerbango, SonicBox
- General problem:
 - Streaming is power-intensive
 - Device receiving and processing the audio signal from Internet preferably runs on mains electricity
- Trend since 2010: Broad range of products



Kerbango's Internet Radio



SonicBox device



Logitech Squeezebox



Pure One Flow



Sony CMTMX750NI



Medion P85015



Parrot Asteroid Car Radio

Value Production Chain for Web Radio (Germany)



Goldmedia Webradiomonitor, im Auftrag der BLM (5. Juli 2010)

Internet Radio Market (1)

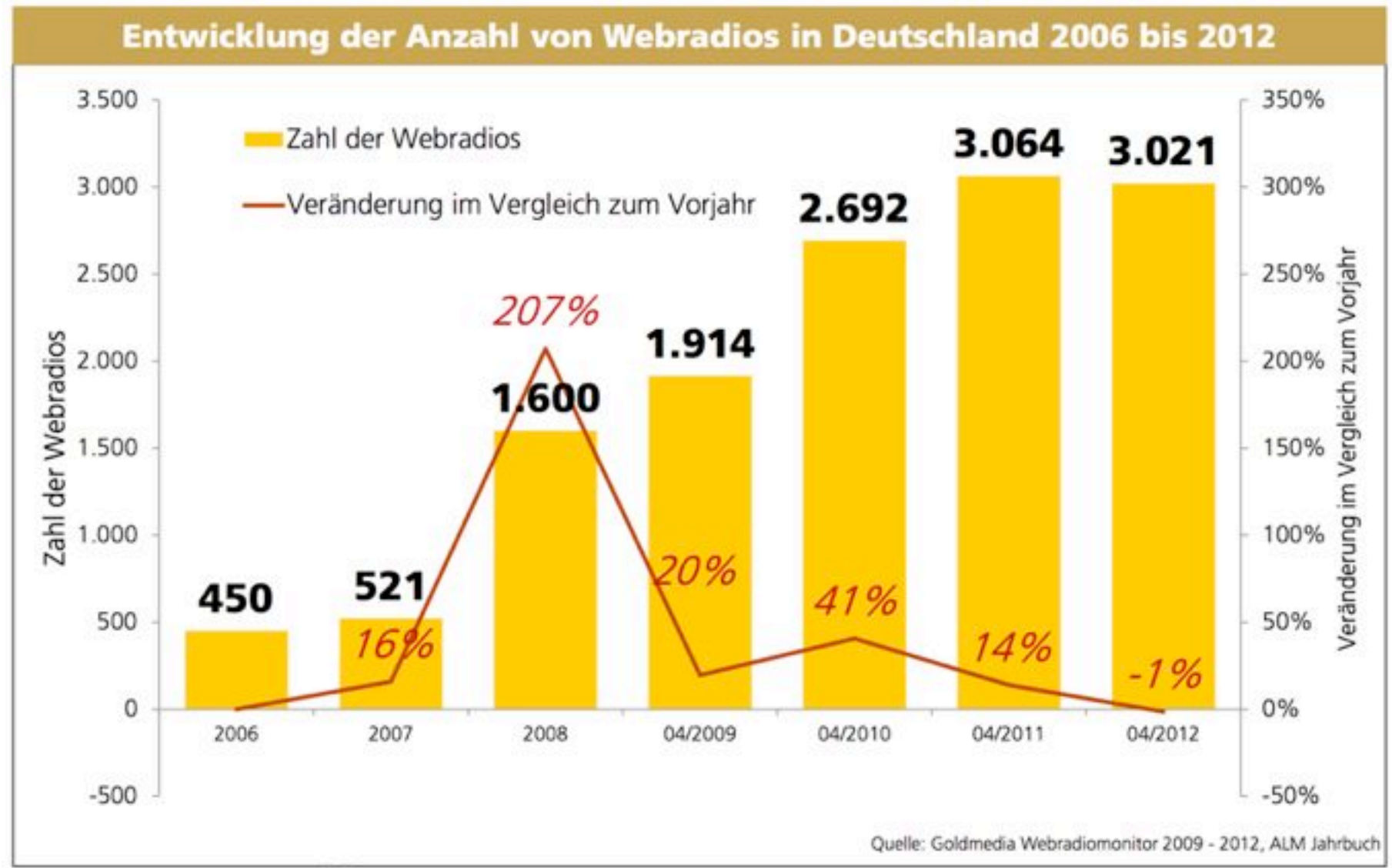

Internet Radio Market (2)

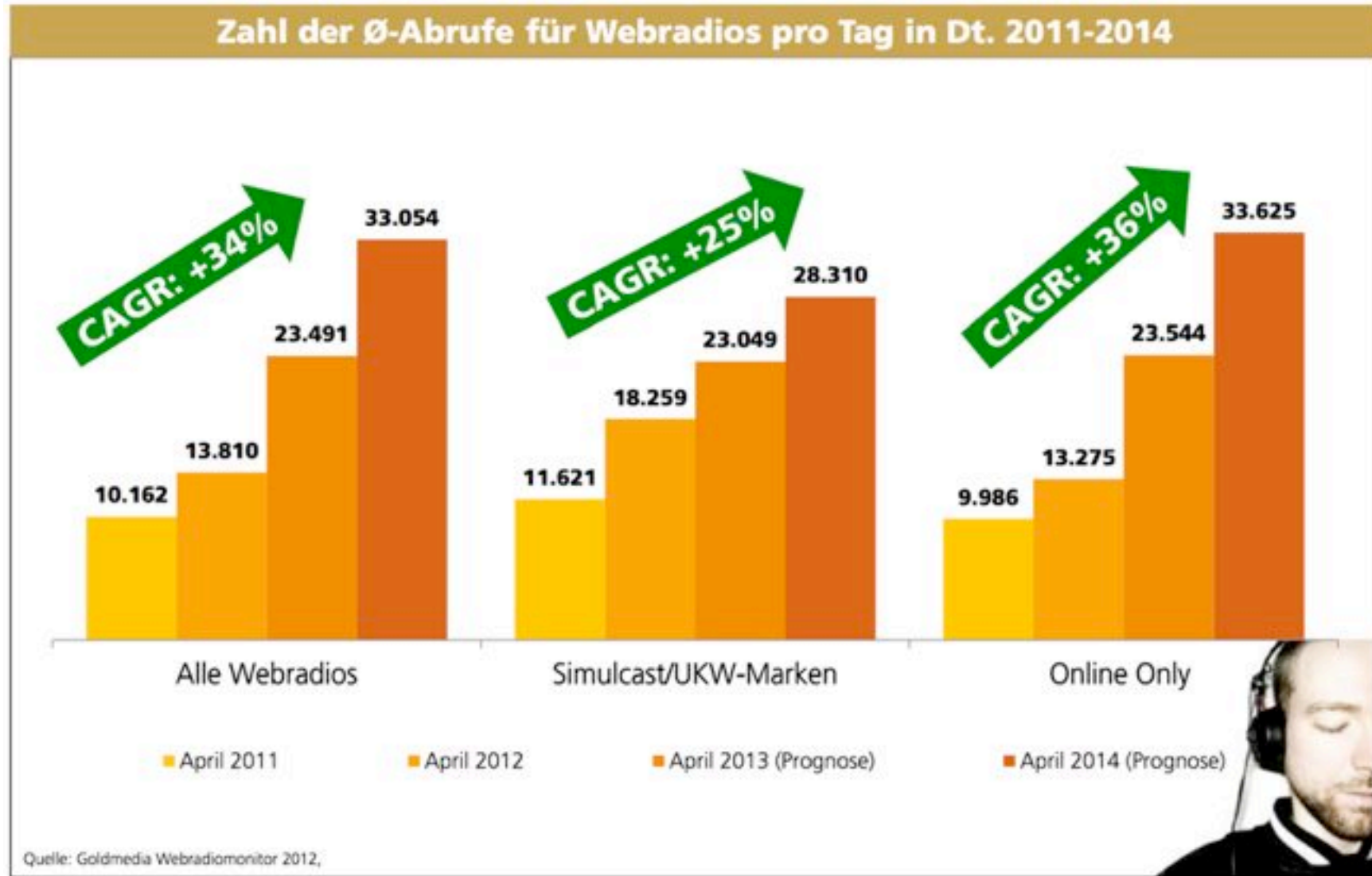

Internet Radio Market (3)

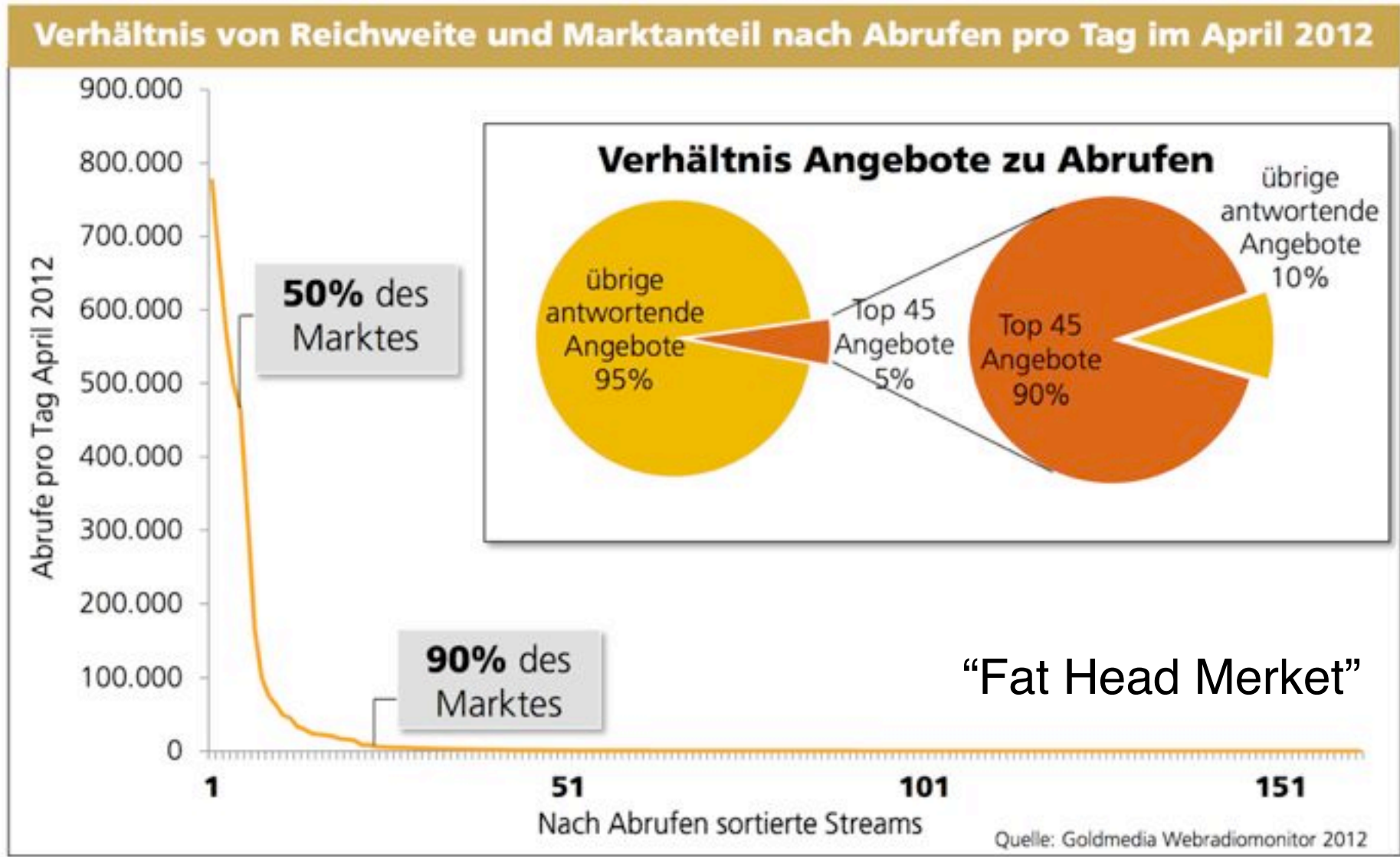

Internet Radio Market (4)

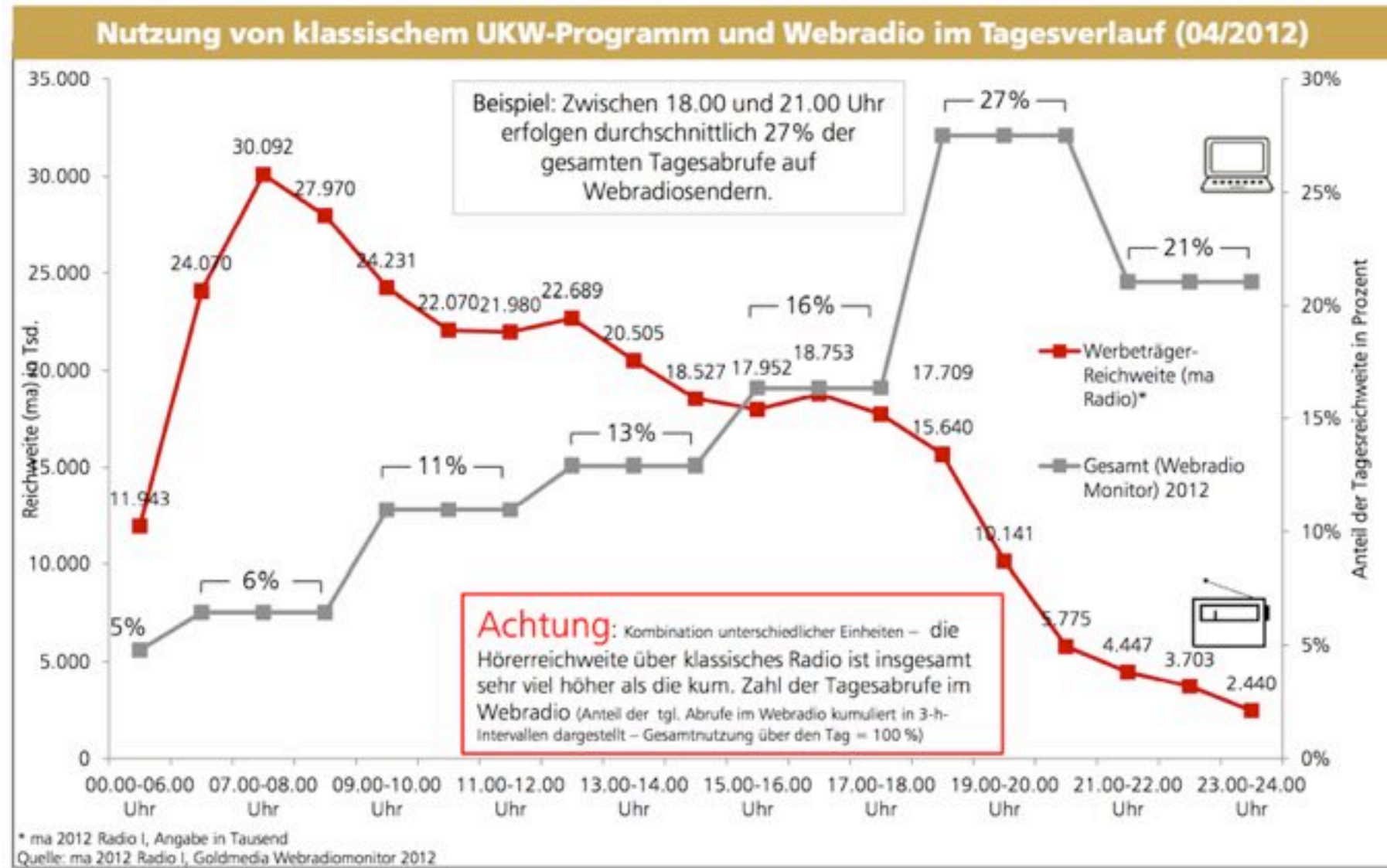

Internet Radio Market (5)

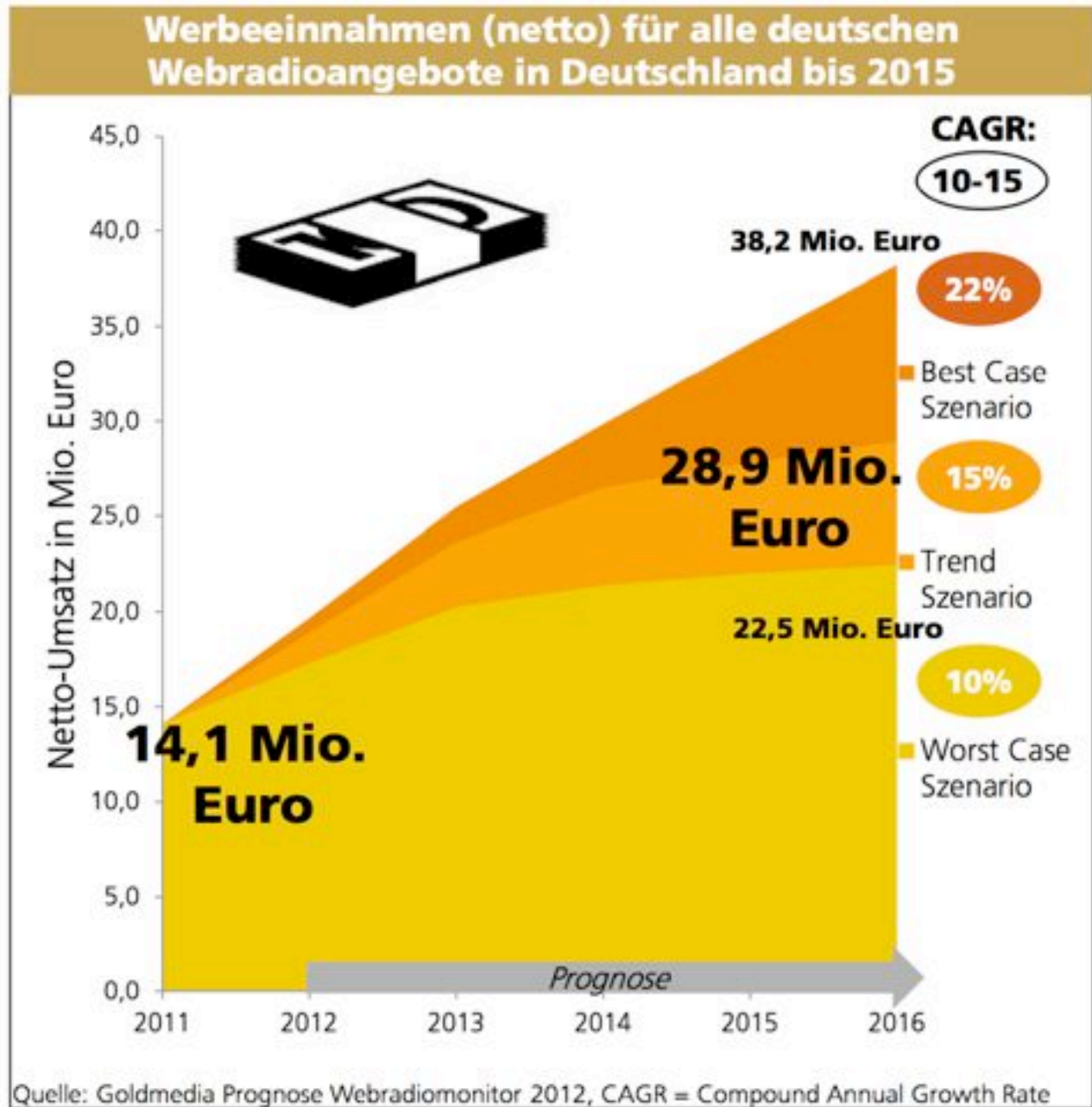

Trend 2012: Mobile Usage of Web Radio

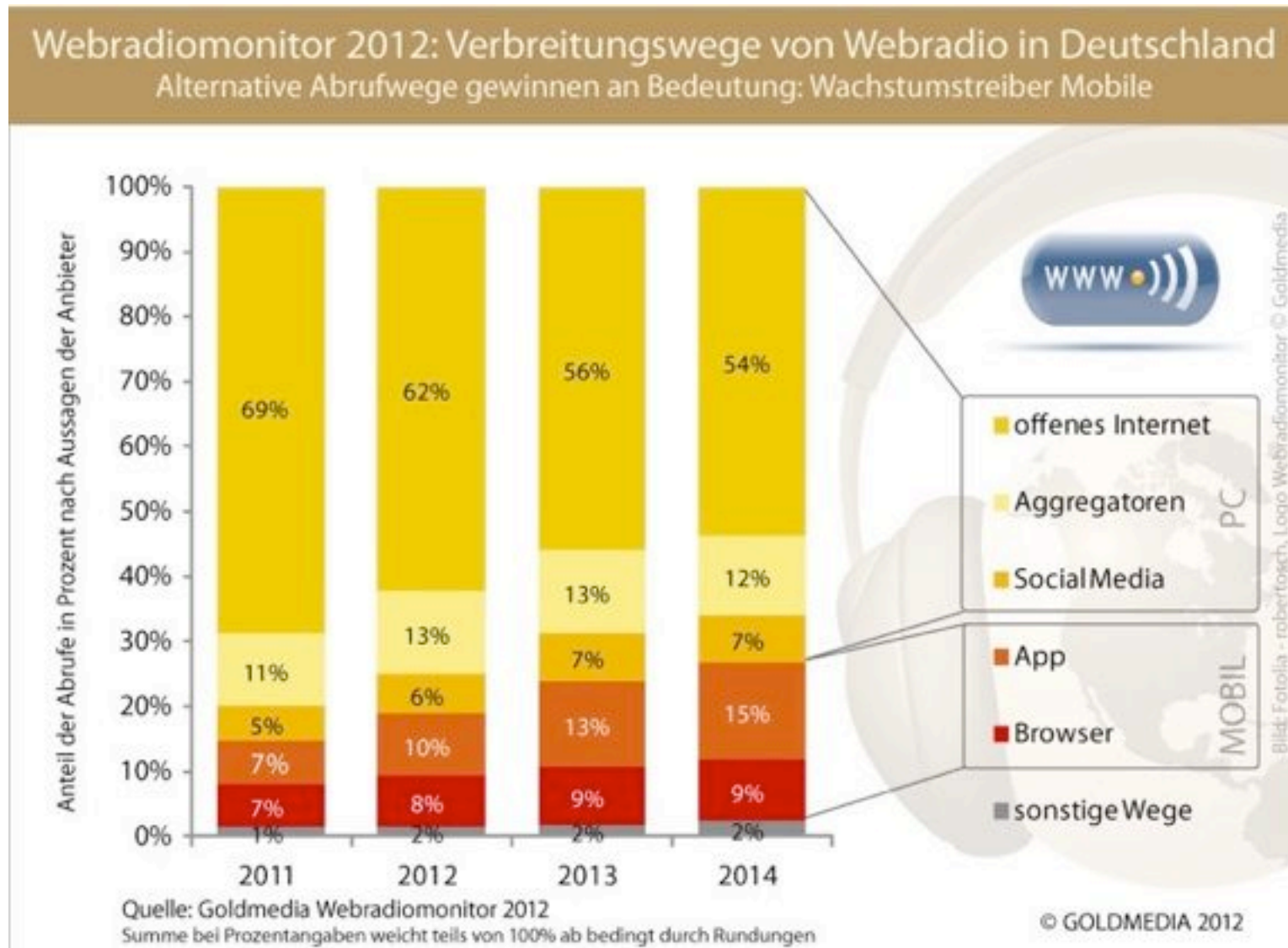

Copyright and Web Radio

- Fundamental problem #1:
 - Traditional radio (terrestrial, cable) receivable only within clear location limits
 - » Partially also true for satellite transmission
 - Web radio in general receivable globally
 - » Anything receivable in U.S. is subject to U.S. legislation!
- Fundamental problem #2:
 - Replication of digital content is very easy
 - Capturing Web radio streams
- Web radio stations are extremely “visible” - simple to trace!
- Example: U.S. DMCA (Digital Millennium Copyright Act) rules
 - Limits how often playlisted tracks can be repeated within 3 hours
 - Limits on the number of complete tracks from the same album played in proximity
 - Limits on pre-announcement of coming-up tracks
 - ... Targeted at fundamental problem #2

Example: Clearchannel Stations

- Radio program was simulcasted on Internet
- Speakers of advertisements went to court
 - Special fees for higher audience numbers than agreed on
- Technical response:
 - Different versions for Internet and local radio broadcast
 - Advertisements are automatically adapted
 - » On locally broadcasted program: As before, with local significance
 - » On Internet: Advertisements are replaced with globally valid advertisements
- Problems:
 - Technically and in administration view: difficult
 - Adaptation to global standards may annoy listeners from local community

Example: Pandora



Dear Pandora Visitor,

We are deeply, deeply sorry to say that due to licensing constraints, we can no longer allow access to Pandora for listeners located outside of the U.S. We will continue to work diligently to realize the vision of a truly global Pandora, but for the time being we are required to restrict its use. We are very sad to have to do this, but there is no other alternative.

We believe that you are in **Germany** (your IP address appears to be **84.** . If you believe we have made a mistake, we apologize and ask that you please contact us at pandora-support@pandora.com

Radio and Visual Information

- **Traditional radio** is a medium for the ears only
 - Most adequate interaction forms are also based on audio
 - » Telephone participation of listeners
 - Additional information may be shown visually (e.g. RDS)
 - Spot advertisement
- **Web radio** can be used as hybrid audio/visual medium
 - On PC, Smartphone, TV set, ...
 - Interaction is greatly eased by using visual information
 - Spectrum of intensity of visual information
 - » Sender logo only
 - » Subtitles with additional information
 - » Additional text (information, interaction)
 - » (Still) Pictures
 - » Video
 - » Banner advertisement!

Sophisticated Interaction Forms for Web Radio

- *Interaction highly integrated with programme*
- Interactive playlists
 - “Wunschkonzert” (musical request programme)
 - » Individual requests or democratic voting
 - » Automatic overall optimization of playlists
 - Requests may be sent in via Web, email, SMS, ...
- Upload of music and speech contributions
- Interactive games
 - e.g. Guessing of title, artist, ...
- Web radio enables *automatic interaction forms*
 - Little or no manual interaction on sender side
 - Is this still “radio”? Don’t we expect a live moderator?
- Integration with e-commerce offers

Web Radio / Music Shop Integration 2004

The screenshot displays a web interface for 'Webradioantenne' and 'Music Shop'. The left sidebar features the radio player with a live stream of 'ANASTACIA, SICK AND TIRED'. The main content area shows search results for 'ANASTACIA, SICK AND TIRED' in the music shop, listing items like 'Amos, Tori: Under The Pink' and 'Anastacia: 50 Anos De Forro'.

Web Radio / Music Shop Integration 2011

Antenne.de / Radio / Sendungen

Das lief im Webradio

> Channel: **ANTENNE BAYERN**

Counting Crows Feat. Vanessa Carlton mit "Big yellow taxi"
lief am 12.01.2011 um 12:26 Uhr

Nickelback (» Fotos) mit "If Today Was Your Last Day"
lief am 12.01.2011 um 12:23 Uhr

Welcher Titel lief im Radio?

Musik, die Sie im Programm gehört haben!

ANTENNE BAYERN

An welchem Tag und um wieviel Uhr (hh:mm) haben Sie den Titel gehört?

12 : 35 12.01.2011

suchen

Big Yellow Taxi
Counting Crows

Titel: 3:45 min
Genre: Pop
Typ: MP3
Qualität: 320 kb/s
€ 1.29

Titel: min
Genre:

Titelliste

Titel	Interpret	Format	Preis	Aktionen
1.			min	

Web Radio / Music Shop Integration 2013

|| ANTENNE BAYERN Stream wird abgespielt. 🔊

Aktueller Titel:
Everything At Once
Lenka

📌 Kaufen

👍 1,2 Tsd.
👍 Gefällt mir

Full text search on amazon.de MP3 archive

Vision of a “Killer Application”? (from 2002)

- The “I want this” button on the car radio
 - On the road, the button is simply pressed when interesting music plays
 - Later, online and in the music store:
 - » Selected music is offered for (selective) buying
 - “I want this” buttons on other devices?
 - » PDA, mobile phone?
- General requirement:
 - Automatic networking of various devices
- Possible path to solution:
 - Integration of music player and mobile telephone
 - Integration of “nomadic” devices into car user interfaces
- 2012: Maybe it is an “I Like” button customers want?

Trends in Web Radio 2012

- According to Webradio Monitor Study 2012 (Goldmedia, Germany)
- Constant growth
 - +36% playback requests in 2012 compared to 2011
 - Traditional FM brands (simulcast and online-only sub-brands) dominate (82%)
- Rapid increase in usage over mobile devices (smartphones, tablets)
 - 57% interviewed persons assume replacement of analog FM radio
- Advertisement placement:
 - Still mainly display ads on Web home page (visual)
 - Increasing use of spot advertisement (online spots and pre-roll spots)
- Integration with Social Media is promising
 - But not (yet?) as broadcasting medium
- On-demand radio (e.g. Spotify, Napster, Simfy) not seen as competitor
- Low prospects for paid radio services

11 Web Radio, Web TV and IPTV

11.1 Web Radio

11.2 Web TV

11.3 Audio and Video Streaming over IP

Literature:

David Feinleib: The inside story of Interactive TV and
Microsoft WebTV for Windows, Morgan-Kaufmann 1999

Johan Hjelm: Why IPTV? Interactivity, Technologies and Services,
Wiley 2008

What is WebTV?

- Tentative criteria for WebTV:
 - Web site with video/moving picture as central element
 - Usable with standard browser software
 - » Plugins may be required
 - » True streaming, download, progressive download
 - Frequent actualizations
- Difficult to distinguish from:
 - Enhancements of digital broadcast TV
 - » E.g. Catch-up TV
 - Video podcasts

Web Radio and Web TV

- In principle, the same questions as for Web radio:
 - Bandwidth problems
 - » much higher requirements
 - Separate medium or simulcast of existing medium
 - Live stream or download
 - Adequate end system
- Quality differentiation
 - Live stream with limited resolution compared to main program
- Possible end systems for Web TV:
 - Computer
 - TV set (“Smart TV”)
 - PDA, mobile phone
 - Special mobile devices (e.g. DVD player/DVB-T receiver)
- Interactivity of TV programs?

WebTV: Complex Value Chain



TV Drives Growth of Online Video Usage

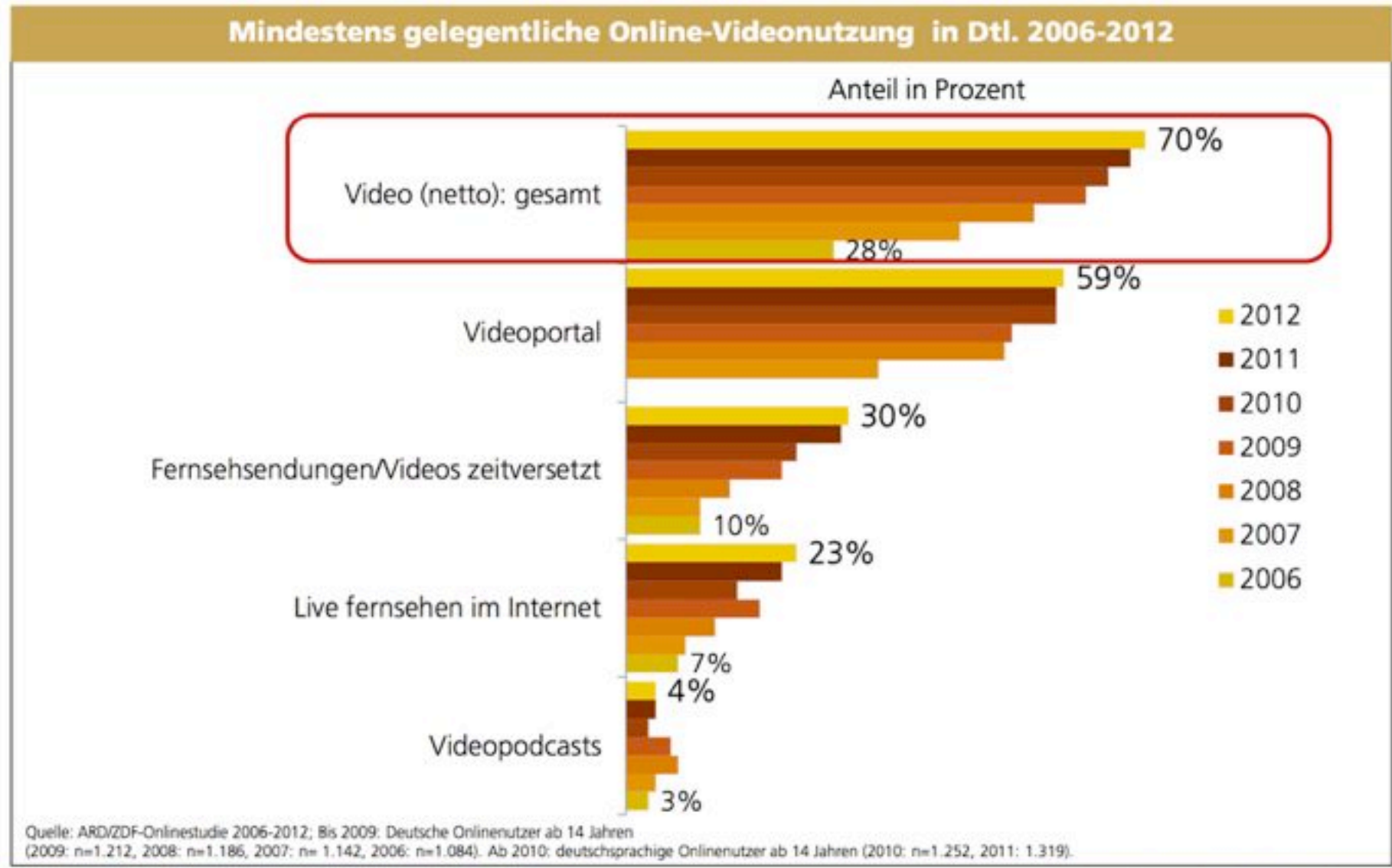

Platforms for WebTV

PC usage decreases

Smart TV and mobile devices increase

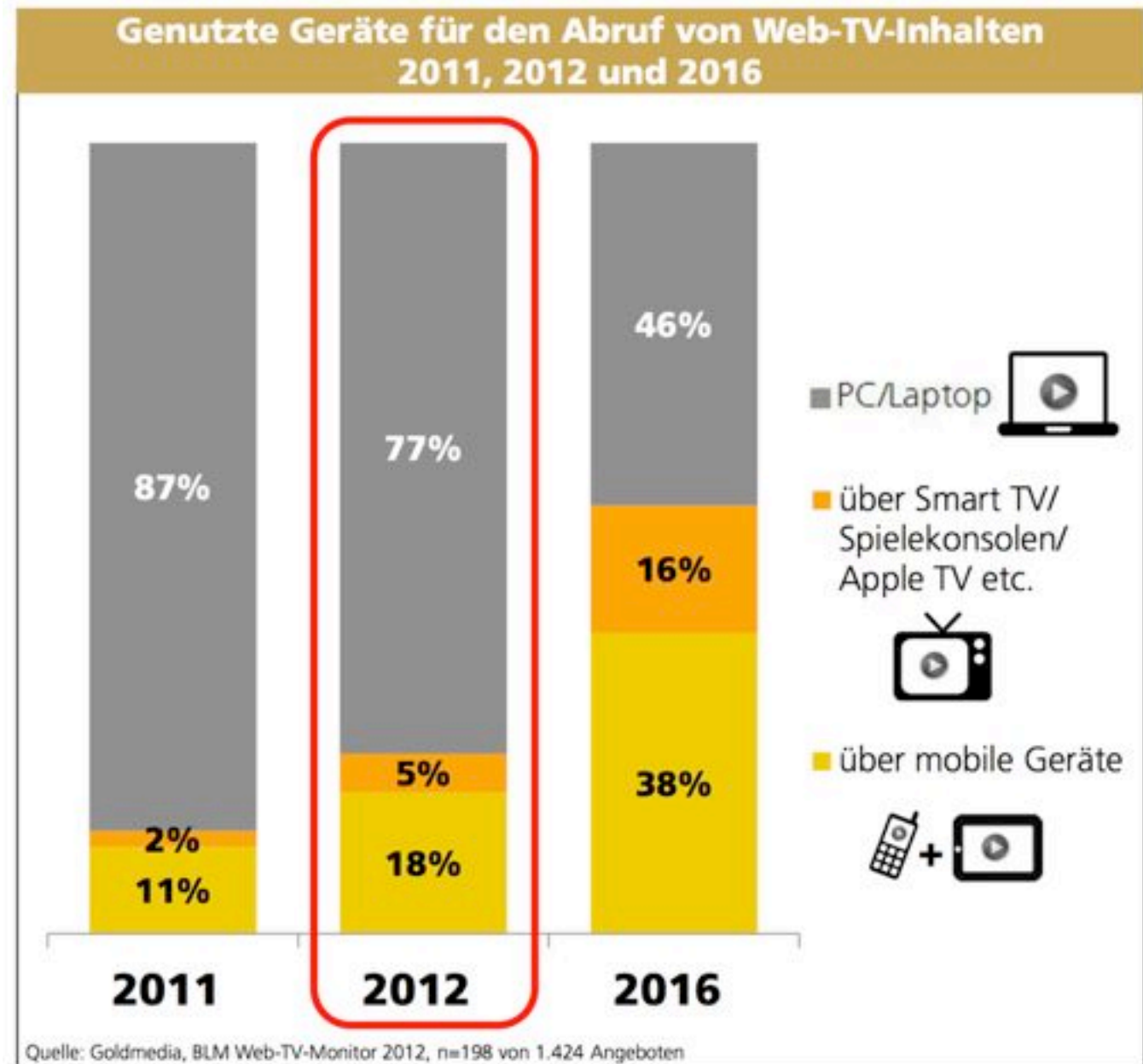

Web TV Simulcast

- Many streams available
 E.g. de.wwiTV.com lists 70 live TV streams only for Germany (Jan 2013)

NsdqC	2135.20	-0.51%
NsdqF	1619.50	+0.56%
Nikkei	11103.42	+0.23%
EUR/\$	1.3358	
Gold	441.975	
ÖlBrent	43.10	

• American Express Gold Card + USB-Stick 128 MB oder Reisetrolley - jetzt kostenlos!
 • 6% mit BMW Spar&Invest. Die Erfolgskombination mit dem Top-Zins.

TV-Highlights

n-tv
2004

Web TV Simulcast – Nine Years Later

Jetzt
n-tv live

Hauptversammlung 2013

SIEMENS-HAUPTVERSAMMLUNG
Aktionäre überwiegend zufrieden

USÖL -0,2% | DELL 13,05 -0,5% | DISNEY 53,40 +1,3% n-tv 18:24

DAS NEUESTE MEISTGESEHEN

- n-tv Sport kompakt
23.01.13 – 01:27 min
- n-tv Wirtschaft kompakt
23.01.13 – 01:31 min
- n-tv Nachrichten kompakt
23.01.13 – 02:11 min
- Sendung in voller Länge
Telebörse von 15:40 Uhr
23.01.13 – 12:21 min
- Sendung in voller Länge
Nachrichten von 15:00 Uhr
23.01.13 – 15:36 min

History of Interactive TV: Microsoft WebTV and ATVEF

- ATVEF: Advanced Television Enhancement Forum Initiative
 - Industrial consortium: CNN, Disney, Intel, Microsoft, Sony, and others...
 - Defined standard 1997-1999
 - Triggers embedded into TV programme to activate Web-based content
 - » “crossover links”
 - » Using the Vertical Blanking Interval (Austastlücke)
 - To synchronize Web presentations with TV content
- Microsoft’s WebTV initiative
 - Selling set top boxes
 - » Web browser and ATVEF decoder
 - Providing interactive content through media partners
- Historical failure...
 - ATVEF no longer supported in 2004

Microsoft MSN.TV



- Short term commercial interest (2004):
 - TV as end system for Internet access (Web/email)
 - Integrated media player
 - No integration with TV programmes

Examples of Interactive TV from MS WebTV

- Enhanced versions of popular soaps like “Baywatch”, sports reporting, news, and game shows
 - For some time produced by NBC and other large stations
- Background information for TV drama:
 - Information of actors currently seen (name, pictures)
 - Information on location (including advertisements)
 - Additional views not visible on TV
 - “What happened until now” function
- Background information for sports programmes:
 - Players, team history, medal counts, ...
- Customized information in news programmes:
 - News tickers, headlines, travel news customized for individual viewer (selected by set top box)

Screenshot from Interactive Version of Baywatch

The screenshot displays an interactive interface with a blue background. On the left, there is a photo of a woman in a yellow top attending to a patient in a hospital bed. Below it is a CT scan image of a brain. On the right, there is a photo of three people on a boat. The interface includes several text elements: the 'Alaska Airlines' logo at the top, a handwritten note about a patient's injury, a 'Pacific Medical' logo, and a description of a CT scan. A vertical sidebar on the right contains the text 'EXIT HELP WEB' and a series of small thumbnail images. At the bottom, there are two buttons labeled 'See behind the scenes photos of filming at sea.'.

Alaska Airlines

Patient suffered a closed head injury leading to a cerebral contusion - Patient underwater an unknown length of time - currently in a comatose state

Pacific Medical

Computerized Tomography (CT)
Patient: Robby Quinn

Alaska Airlines

EXIT HELP WEB

DIVE BOAT

See behind the scenes photos of filming at sea.

The crew films boat to boat as Leslie (Heather Stevens) prepares to use a scuba tank wrench to knock out her boyfriend.

See behind the scenes photos of filming at sea.

Levels of Interactivity in TV

(according to Johan Hjelm 2008)

- Level 1: Interaction with meta-information about the TV programme
 - Electronic/online program guide
 - Personal video recorder
- Level 2: User accesses external information
 - Teletext
 - On-device portals
- Level 3: User influences program by voting
 - Big Brother, Americal Idol etc.
 - May include chat and other interaction with other users
 - Either through separate phone/Web interaction or through Set Top Box
 - » UK: BBC/BSkyB: "red button" for interactive services / teletext
- Level 4: Story or other content of TV program changed by interaction
 - Simple form: Add-On multimedia material (e.g. BskyB "green button")
 - Extrapolation: TV converging towards games

Success Stories of Interactive TV?

- Voting is popular:
27 % of all young European users of mobile phones have voted or otherwise participated in interactive game shows via phone
- BBC:
During 2004 Olympics, more than 60% of viewers watched the event in an interactive way
- Johan Hjelm, based on research of EU project LIVE:
 - Interaction works best in documentaries and news
 - In fiction, people want interaction as unobtrusive as possible
 - Most viewers are not programmers, and they *may not know their own needs*
 - People want to belong to groups
 - TV viewers expect to be surprised

Interactive TV 2013?

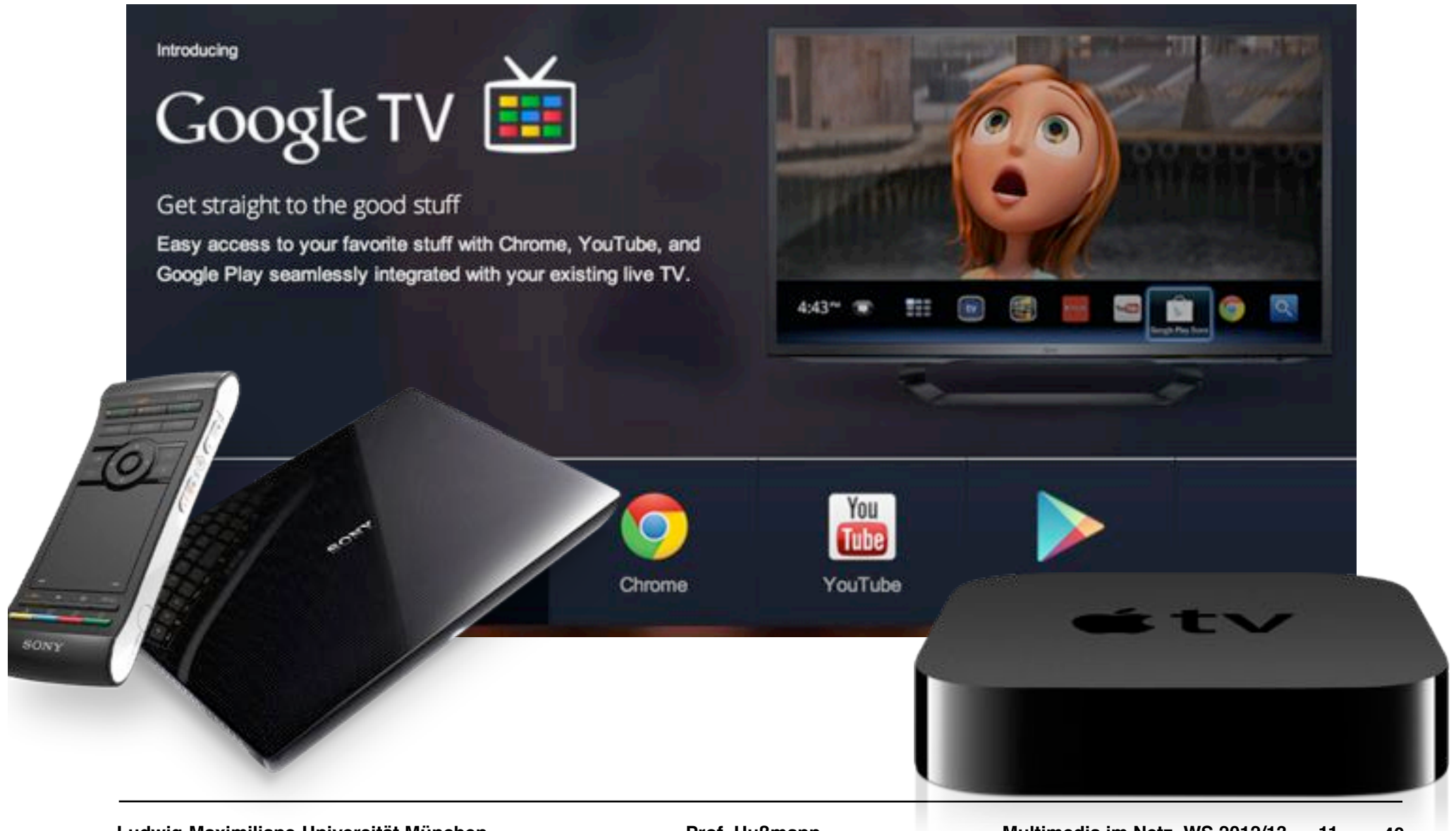

Hybrid Broadcast Broadband TV (HbbTV)



- European initiative
 - Standardization through ETSI
 - Based on Multimedia Home Platform (MHP)
- Founding members of consortium:
 - ANT Software, EBU, France Televisions, IRT, OpenTV, Philips, Samsung, SES ASTRA, Sony, TF1
- Many additional supporters, e.g. from Consumer Electronics:
 - Haier, Humax, Loewe, Sharp, TechniSat, TopField, VBox
- Standard supported by devices from most major brands:
 - (additionally:) Grundig, LG, Telefunken, Toshiba, Panasonic
- Many broadcasters offer actual service:
 - ARD, ZDF, ARTE, RTL, SAT.1, Pro7, ...
- Basic idea:
 - Replacement for traditional videotext by bi-directional Internet channel
 - TV or Set Top Box to be connected to Broadband Internet

HbbTV Service Examples: Menus



“Red button” on Remote Control for start/termination

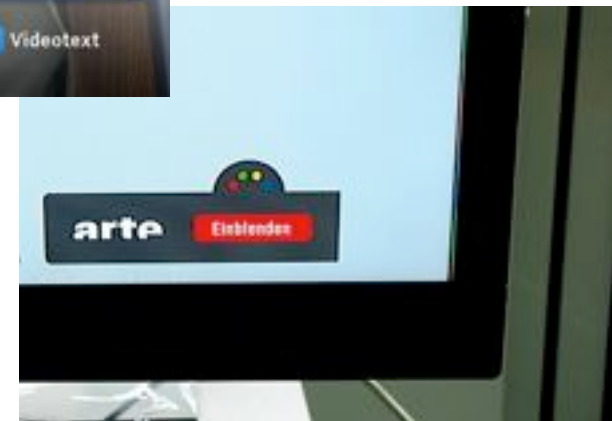

HbbTV Service Examples: Mediatheken

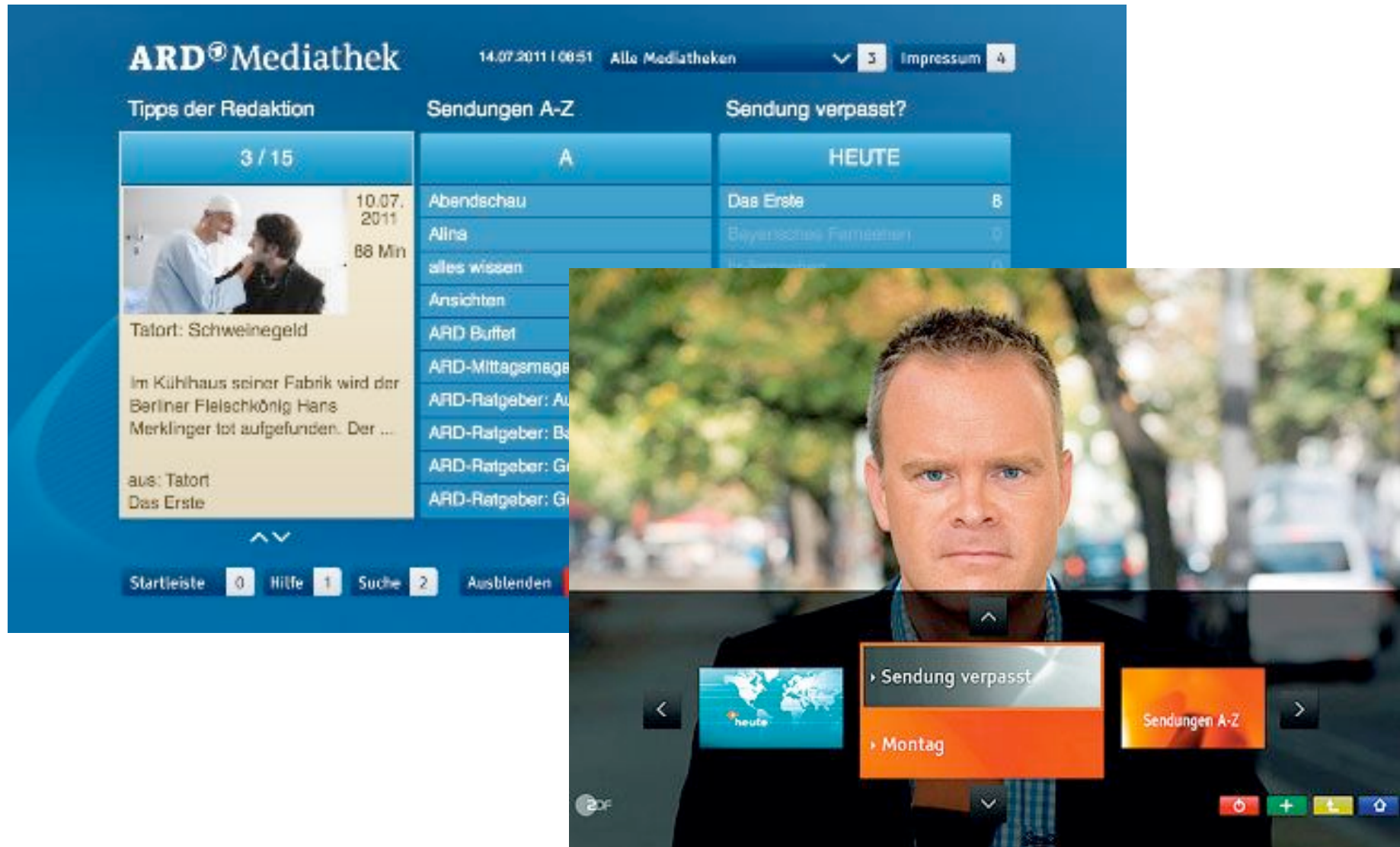

HbbTV Service Examples: Data Presentation

The screenshot displays the BR Bayerntext HbbTV interface. At the top left, the logo 'BR BAYERNTEXT' is visible. Below it, a navigation menu lists various services: 'Seite 601', 'Startseite', 'Nachrichten', 'Bayern', 'Sport', 'Fernsehen', 'Radio', 'Wetter', 'Verkehr', 'BR-Intern', 'A-Z', and 'Hilfe'. The main content area is divided into three sections. The left section, titled 'Wetter', shows the date and time 'Donnerstag, 29.09.2011 | 16:26' and a weather summary 'Vielerorts sonnig, Höchstwerte 18 bis 26 Grad.' Below this is a map of Bavaria divided into regions: Unterfranken, Oberfranken, Mittelfranken, Oberpfalz, Niederbayern, Schwaben, and Oberbayern. Each region has a weather icon and a temperature value. The right section, titled 'Jetzt im Bayerischen', features a video player showing a woman and a list of programs: '15.30 Wir in Bayern', '16.45 Rundschau', and '17.00 Das etwas andere Bier: Zoigl'. At the bottom, a navigation bar includes 'Bayern', 'Regionen', '7-Tage-Wetter', 'Berg-wetter', 'Deutschland-wetter', 'Bio-wetter', and 'Reisewetter'. A legend at the bottom identifies icons for 'Ein | Ausblenden', 'Lesezeichen', 'Hauptmenu', and 'BR Start'.

HbbTV System Overview

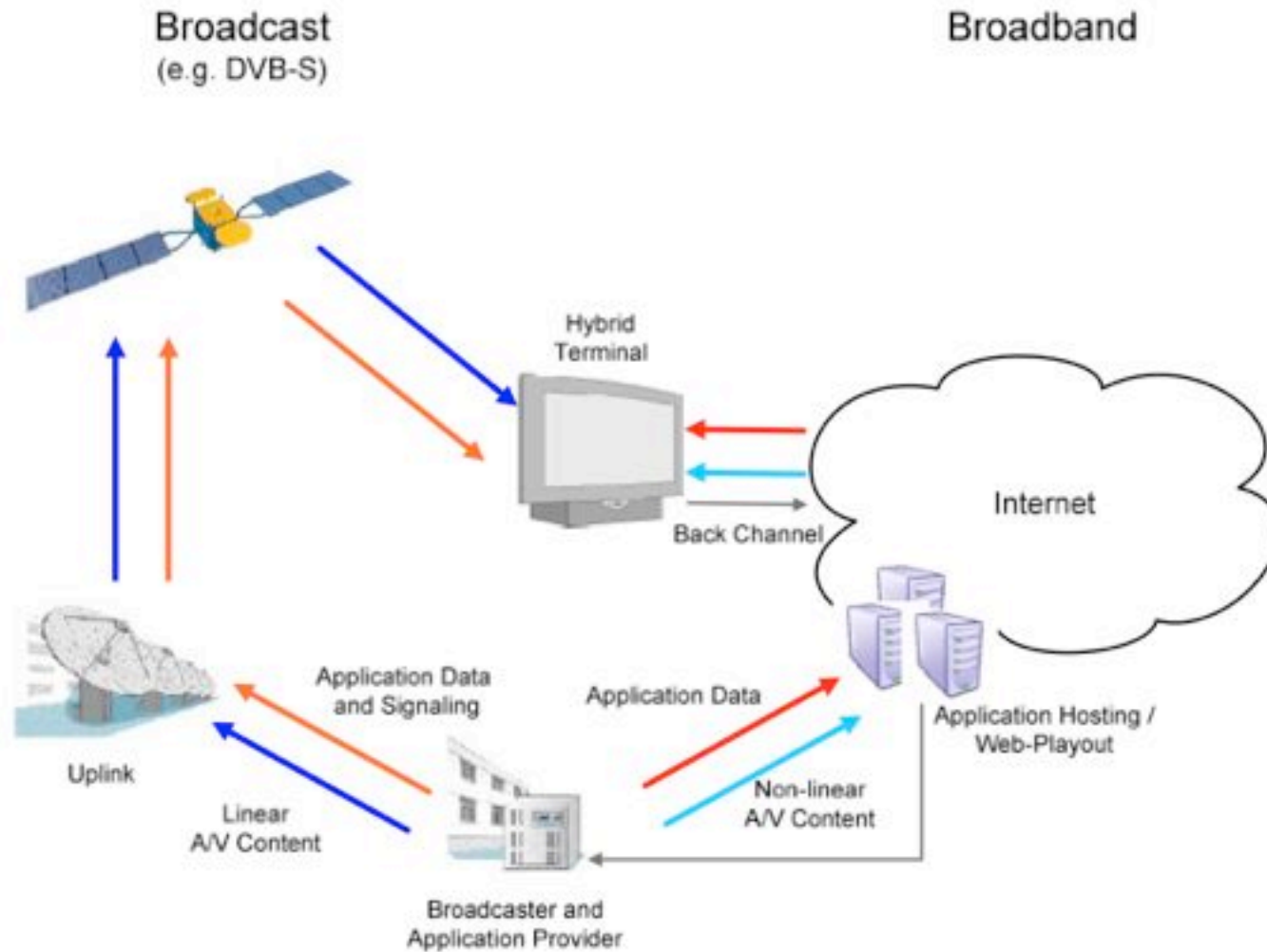
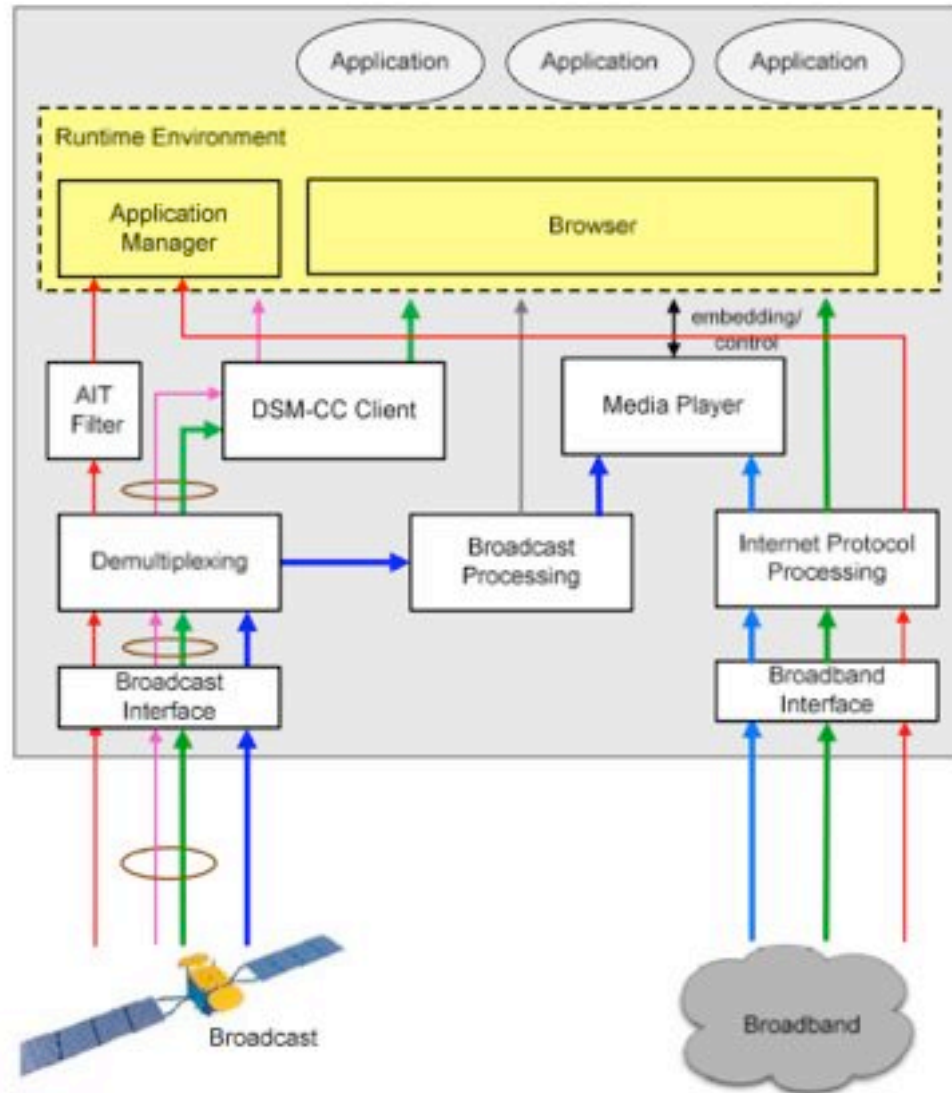
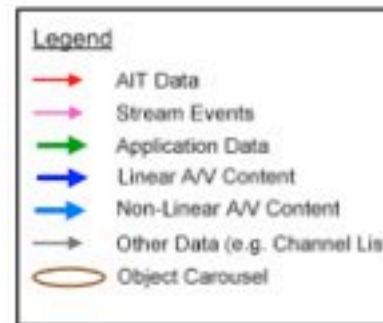

Figure 1: System Overview

HbbTV Terminal Functional Architecture



AIT = Application Information Table
 DSM-CC = Digital Storage Media –
 Command and Control



Digital Storage Media – Command and Control

- DSM-CC
 - Relatively old (1996) ISO/MPEG standard
 - Control interface for digital media delivery
- VCR-like control:
 - Covering client-server setup
 - NPT = Normal Play Time (user-related time scale)
- Multiplexed data embedded into transport stream
 - Data carousel
 - Object carousel

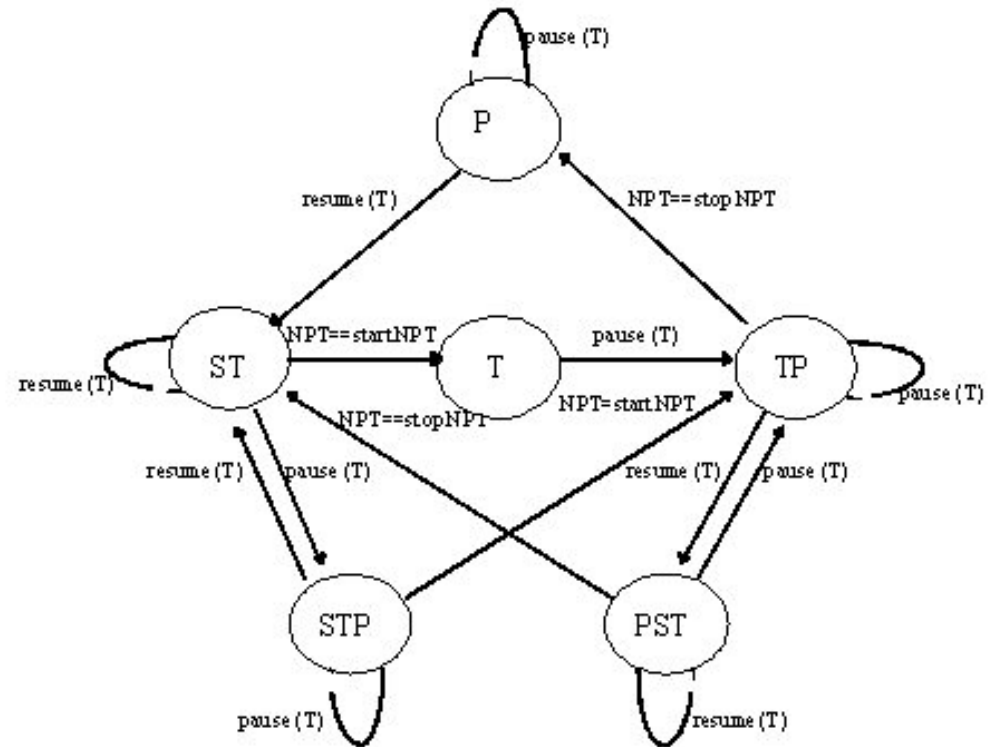

Content Formats in HbbTV

- Browser-based technology: CE-HTML
 - Developed by Consumer Electronics Organization (CEA-2014)
 - Adoption of HTML 4 and CSS to TV sets
- Dynamic interfaces based on JavaScript
 - Using additional, TV-specific APIs
- Declarative Application Environment (from OpenTV forum)
 - Applications based on ECMAScript, SVG, CSS
 - Dynamic DOM, including AJAX-style asynchronous requests
- Various standard image, audio and video formats
 - JPEG, GIF, PNG
 - MPEG1-L3, HEAAC, E-AC3
 - MPEG4 AVC (SD and HD)

Streaming support in HbbTV

- From the HbbTV specification:
- “7.3.2.1 Protocols for streaming
 - Unicast streaming using HTTP 1.1 shall be supported as defined in clause 5.2.2.2 of the OIPF protocols specification [4] with the addition that the range header shall be supported in seek operations. The terminal should only buffer data equivalent to approximately 10 seconds of normal play in advance of the current play position unless the download rate is consistently lower than the consumption rate.
 - Where unicast streaming of non transport stream based MPEG4/AVC video and MPEG/AAC audio using RTSP and RTP is supported, this shall be as defined by clauses 6, 7 and 8 of ISMA [6]. The terminal shall support the "Interleaved RTSP & RTP/AVP over TCP transport" method. For audio and video the restrictions of the present document apply.”
- OIPF = Open IP TV Forum, see www.oipf.tv

10 Web Radio, Web TV and IPTV

10.1 Web Radio

10.2 Web TV

10.3 Audio and Video Streaming over IP

Literature:

Johan Hjelm: Why IPTV? Interactivity, Technologies and Services,
Wiley 2008

Traditional TV, Web TV and IPTV (1)

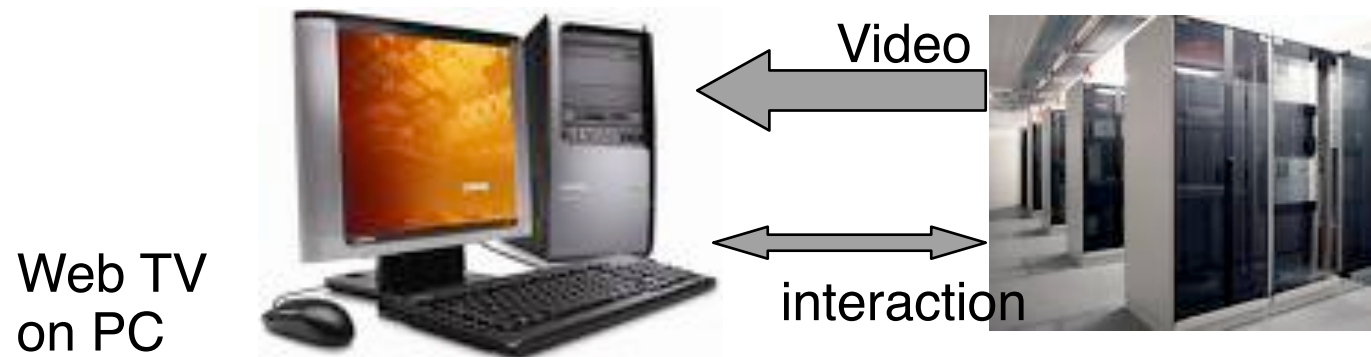
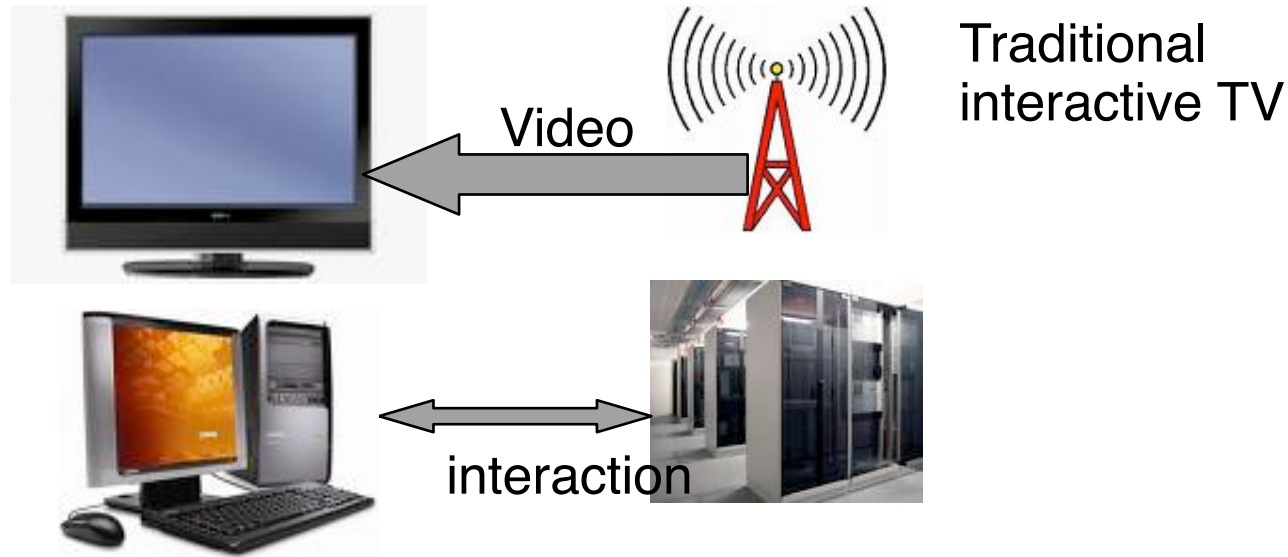

Traditional TV, Web TV and IPTV (2)

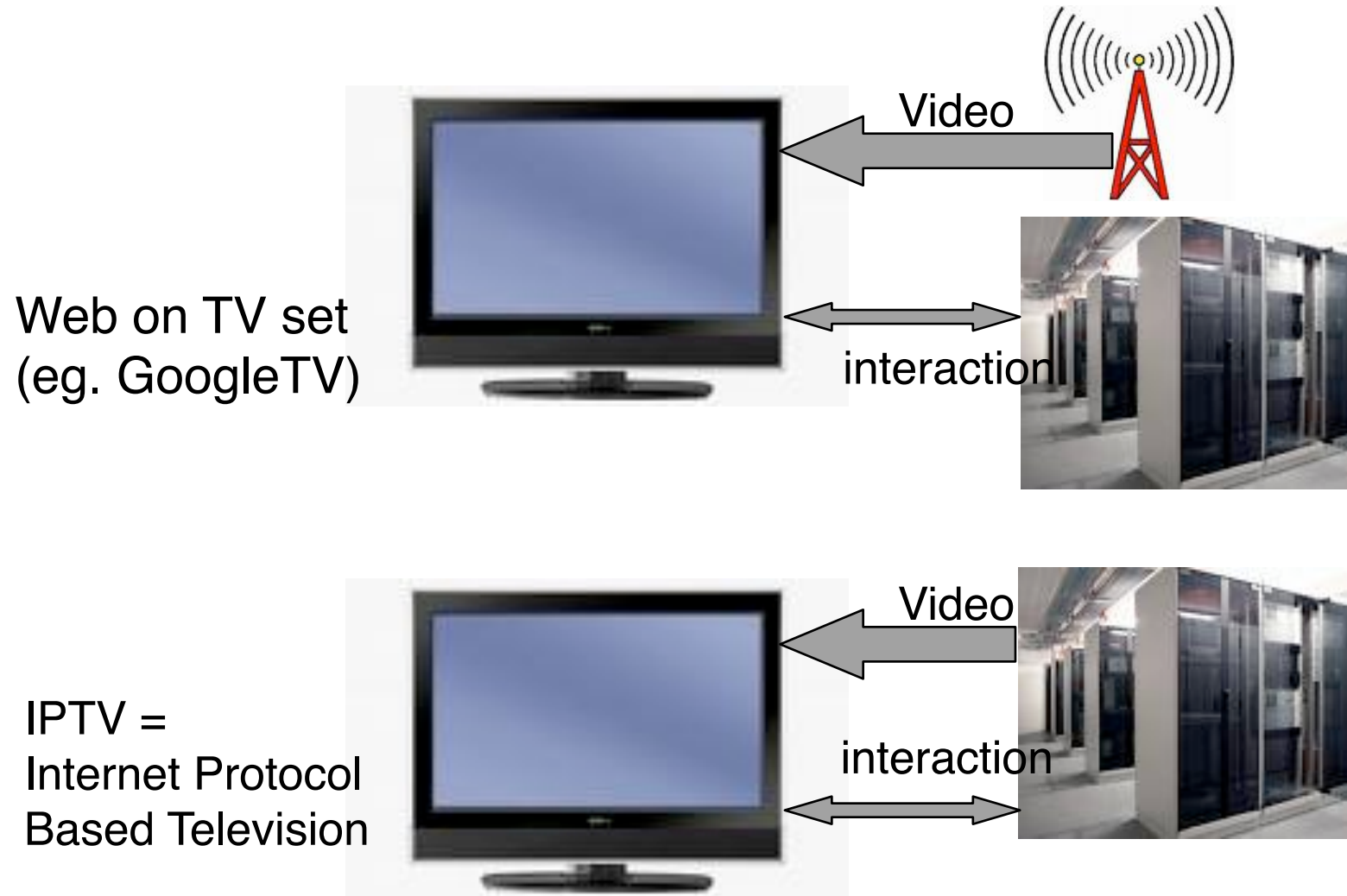

TV programme is carried over Internet, no radio broadcasting or TV cable

Profile & Presence

- Users need to be authenticated for IPTV
 - Subscription management
- *Presence* information can be valuable for interactive TV
 - Who is online?
 - Who of my friends is watching this?
 - Real-time recommendations
- Presence can be managed in two ways:
 - Server/application based (e.g. Skype), heterogeneous solutions
 - Network based standard solutions
(e.g. presence support in IMS, based on 3GPP)

Media Streaming in Home Networks



- Streaming solutions for the home network:
 - Streaming audio, video and images from server to clients (e.g. TV set)
 - Streaming audio and video from CE devices
 - » e.g. TV program from TV tuner to mobile devices
- Dominating standard:
DLNA
(Digital Living Network Alliance)
 - based on Universal Plug and Play (UPnP)



DLNA: Streaming Protocols and Media Formats

- Streaming:
 - HTTP 1.1 streaming over TCP as standard method
 - RTP streaming optional
- Media formats:
 - JPEG, LPCM, MPEG-2 as standard formats
 - Other formats optional: MP3, AAC, MPEG4, ...

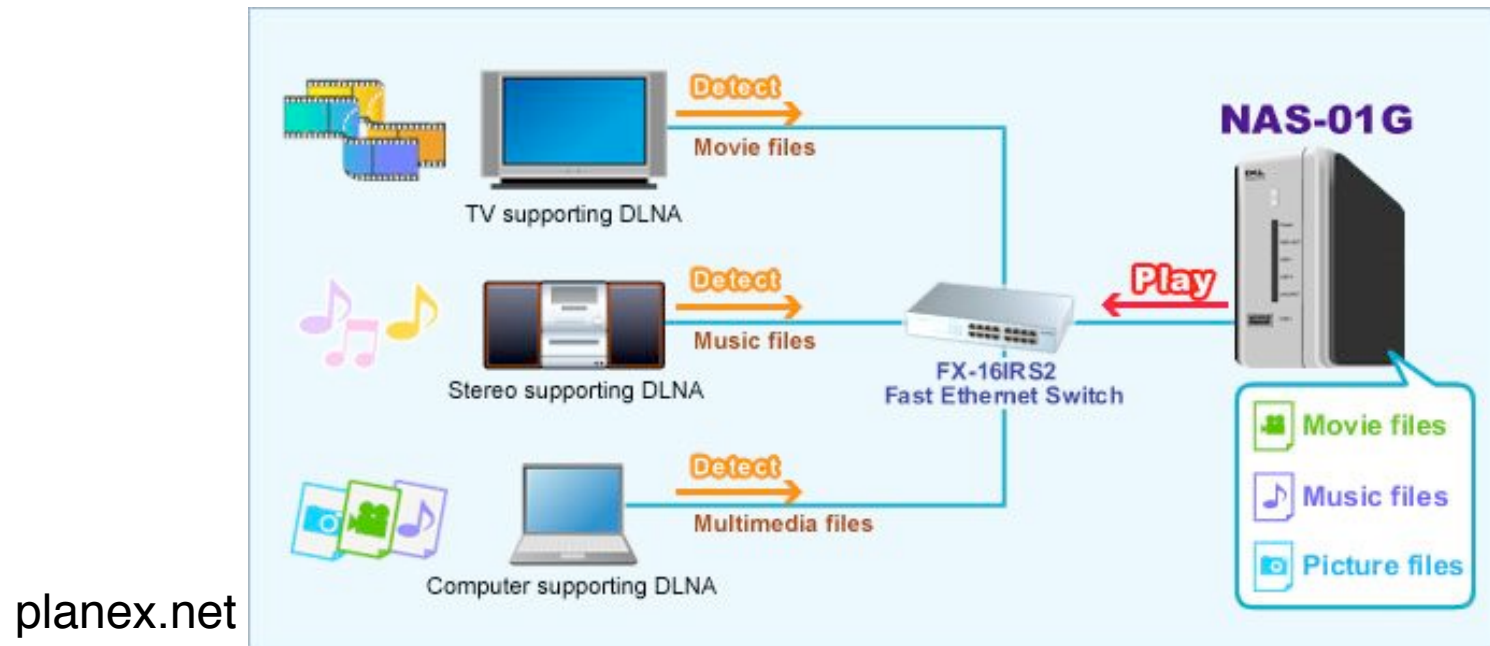

Streaming Technology Applications 2013

- IP networks tend to replace all traditional networks
 - Phone network
 - Home networks
 - Broadcast networks (partially)
- IP and Web technology creates a huge amount of flexibility for product solutions
- Intelligent solutions for home entertainment and commercial use are on the market and rapidly developed
 - Key problem is user acceptance and usability

WebTV and Traditional Broadcast TV

